



















































































































MODECO
EXPERT

CATALOGUE 2023

HAND TOOLS, POWER TOOLS
AND ACCESSORIES



PICTOGRAMS

 Magnetic tip	 Satin surface finish	 M36 M36 staple	 Additional blades	 S2 steel	 Plastic
 Tip hardness 48-52 HRC	 1/2" drive	 M300 M300 nail type	 Quick blade replacement	 Concrete	 Key less mount
 Insulated blade 1000 V	 Satin surface finish	 Sharpened tip	 3 step blade extending facility 1..2..3	 Brick	 Minimum thickness of riveted material min. 3 mm
 Pliers jaws hardness ~56 HRC	 Chrome Vanadium Steel	 Zinc coating	 Number of blades included 10x	 Aluminum	 Additional blades
 Maximum spacing Ø 35	 Reversible ratchet handle	 1000pcs in a box	 Safety lock	 Wood	 Quick blade replacement
 Pliers working range max Ø 0,5-60	 Torx key tip	 M53 staple	 Quick replacement facility	 Steel	 Non slip handle
 VDE-certified	 Hardness of wrench jaws 44-48 HRC	 Made in Poland	 Plastic handle	 Plasterboard	 Cable cutter
 Insulated handles 1000 V	 Satin surface finish	 Lifetime guarantee 100 YEARS	 3 cutting edges	 Gres Tiles	 Made of chromium-molybdenum steel
 External circlip pliers	 Ball end shaft for working at angles 25°	 ABS plugs	 Fine tooth saw tip easy start	 Stal nierdzewna Stainless steel	 18 V LF-ION battery
 Internal circlip pliers	 Cleans	 Reinforced construction	 Special tooth covering	 Paving sett	 Waterproof material
 Hardness of wrench jaws 55 HRC	 Lubricates, ex. padlocks	 Wall thickness	 Hole cutting	 Stone	 Rubber base
 Magnetic tip	 Lubricates, ex. camshaft chains	 Pressure force	 Screw secured blade	 Zinc/Copper	 Max. revolutions speed max 12000 rpm
 Special hexagonal shape MAXXORIVE	 Lubricates, ex. transfer boxes	 Stainless steel	 Two cutting edges	 Arm strap	 Doesn't require water cooling
 x72 72 tooth ratchet mechanism	 Cleans lacquered surfaces	 Wooden handle	 Carbide	 Reduction ring	 Hexagonal grip
 Satin surface finish	 Cleans and lubricates, ex. bicycle parts	 Underlay thickness h	 Special impact cap for hammer tapping	 Upwards mixing effect	 Max. diam. of the diamond hole saw Ø max 75 mm
 Specially profiled offset for obscured spaces	 Lubricates, ex. pistons	 Leakage current approved 1,0 kV	 Tear resistant material 600 D POLYESTER	 Downwards mixing effect	 Stainless steel
 70° offset	 Lubricates, ex. discs	 Blade width 18 mm	 Rubber coated handle	 Homogenous mixing effect	 1/4" hexagonal chuck HEX 1/4"
 Satin surface finish	 PVC folding ruler	 Blade breaker	 ACR system ACR	 Chemical specification Sn60 Pb40	 Wire thickness 0,35mm BRASS
 1/2" drive	 M11 staple	 Additional blades x6 GRATIS	 Bit hardness 56-62 HRC	 Quality standards UDT-CERT ISO 14001 ISO 9001	 Fine brush FINE BRUSH

PICTOGRAMS

















































































































 Inner diameter	 Force adjustment	 Accuracy class	 Hardened steel	 Stone	 Abrasion resistant
 Drying time 35-40"	 Metal hoising	 2 scales	 Aluminum construction	 Steel	 Cut resistant
 3 layers	 Staples view	 Nylon coated	 Solid construction	 Rubber	 Latex
 Filtration class 0.3 µm M FILTRATION CLASS	 Steel rivets	 Nylon guard	 Cutting wheel diameter ø16 mm	 Waterproof	 Strong rubber
 Tear resistant SUPER STRONG	 Aluminum rivets	 Steel tape	 Hole diameter 6 mm	 Washable	 Construction works
 Car tester CAR TESTER	 4 tips	 Double protect	 Cutting wheel thickness 3 mm	 For black boards	 Gripping precision
 Microwave leakage test MICROWAVE LEAKAGE TEST	 Diameter adjustment	 Measurement accuracy ACCURACY 0.4 mm (1 in)	 Screw included SCREW INCLUDED	 Plastic	 Reinforced construction
 AC test NON-CONTACT AC TEST	 Handle opening lock	 Temperature range -20°C +50°C	 Tungsten File WOLFRAM	 Paintings	 2 organizers
 Continuity test CONTINUITY TEST	 Stainless rivets	 Resistance UV	 Half-round cross-section	 Reinforcing mesh MESH	 Metal buckle METAL BUCKLE
 Bent jaws	 Steel rivets	 Shock protect SHOCK PROTECT	 2 scraper blades x 2	 Tensile strength 12 kg	 Drawer with handle DRAWER WITH HANDLE
 Side blades	 Aluminum rivets	 Slope measurement 2.3°	 Scraper blade thickness 2 mm	 Rough surfaces ROUGH SURFACES	 Blade width 19 mm
 Nut grip	 Force adjustment	 Strong weld STRONG WELD	 Thickness of 2 scraper blades 4 mm	 Easy to tear	 Quick blade change QUICK CHANGE
 Narrowed jaws	 Jaws opening 10 mm	 Felt 8 mm FELT	 Tiles thickness range 3-14 mm	 Surface STRONG	 Double sharpening x2 SHARPENING
 Cable cutting	 Pressure force 320 kg	 Aluminium ALU	 Min. grout thickness min. 1 mm	 Clean the gluing surface	 Shears jaw hardness 55-62 HRC
 Clamping force adjustment	 Drilling	 Rubber 18 mm RUBBER	 Solid construction SOLID CONSTRUCTION	 Sticky lasts for 14 days 14 DAYS	 Two-component grip 2C GRIP
 Working range of jaws 40 mm	 Machine cutting	 Cube cut CUBE CUT	 Aluminum trigger ALUMINIUM TRIGGER	 Resistance UV	 Steel frame
 Jaws width 68 mm	 Painting nuts and bolts	 Sponge pad 30 mm SPONGE	 Writing line thickness 2-3,6 mm	 Spray painting	 2 cutting angles 45° 90°
 Jaws opening 75 mm	 Painting rims	 Hardened steel HARDENED STEEL	 Glass GLASS	 Leather LEATHER	
 Working range of jaws ø38 mm	 Temperature resistance 120°C	 Powder coated POWDER COATED	 Wood WOOD	 Tear resistance TEAR RESISTANCE	

TABLE OF CONTENTS













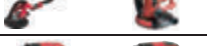
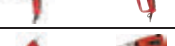
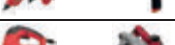
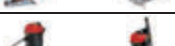
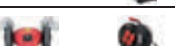







		page
POWER TOOLS		10
Drills, mixers, hammer drills		12
Cordless tools		19
Angle grinders		28
Finishing works		31
Hot air guns		34
Glue guns and soldering irons		36
Woodworking tools		38
Vacuum cleaners		42
Other powertools		46
POWER TOOL ACCESSORIES		48
Bits		50
1/4" drive sockets		53
1/4" bit holders		54
Metal drill bits		57
Wood drill bits		59
Glass drill bits		60
Concrete drill bits		61
SDS plus drill bits and chisels		61
SDS max drill bits		63
Diamond holesaws and crowns		64
Crown holesaws		65
Drill chucks and adapters		66
Saw blades for reciprocating saw and jig saws		67
Abrasives and polishing materials		69
Sanding discs		71
Cutting and grinding discs		71
Stirring paddles		75

TABLE OF CONTENTS





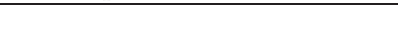



















		page
Wire brushes		76
Welding rods, solders, glues		78
Vacuum cleaner bags		79
BASIC TOOLS		82
Screwdrivers and multi-screwdrivers		82
VDE insulated screwdrivers		86
Voltage testers		87
VDE insulated tools		88
Wire strippers		90
Cable and wire rope cutters		91
Crimping pliers for electrical connectors and terminals		92
Pliers, cutters, pincers		98
Adjustable wrenches		99
Hammers and axes		101
Vices and clamps		105
CONNECTING TOOLS		106
Staplers		108
Staples		109
Riveters		110
Manual benders for drywall sections		111
MECHANICAL TOOLS		112
Open-end and combination wrenches		114
Knobs and ratchets		118
Sockets		120
Toolkits		121
Adjustable and wheel lug wrenches		122
Allen keys		123

TABLE OF CONTENTS



































		page
Straps and slings		125
Technical chemistry		125
MEASURING TOOLS		128
Folding rulers		130
Tape rulers		130
Measuring tapes		132
Square rulers		133
Slide callipers		135
CONSTRUCTION TOOLS		136
Levels		138
Bricklayer staffs and bricklayer's squares		139
Sanding sponges		140
Scrapers and spatulas		141
Trowels		142
Floats		146
Tile cutters		151
Tiling tools		152
Application guns		154
Pencils, chalks, markers		155
Tapes and foils		157
Hooks and crowbars		159
Padlocks		159
Shovels, spades, pitchforks, rakes		159
Broomers		162
Gloves		162
Protective helmets		164
Masks and face shields		165
Protective ear muffs and knee pads		166

TABLE OF CONTENTS

		page
TOOL TRANSPORT ACCESSORIES		167
Tool boxes		168
Tool bags		169
Tool belts and belt accessories		170
CUTTING TOOLS		174
Knives and blades		176
Shears		180
Chisels		184
PVC pipe cutters		184
Taps and dies		185
Saws and saw blades		186
LIST OF INDEXES		190



**MODECO EXPERT | POWER TOOLS, HAND TOOLS,
POWER TOOL ACCESSORIES**
A solid brand you can rely on

You set the goal – we help you achieve it. For 30 years, as the Modeco Expert brand, we have been providing a wide range of high quality tools, tailor-made to fit our customers' specific needs.

Trust cannot be bought, it has to be earned. At Modeco Expert, we have been doing this for over three decades, consistently monitoring the needs of our customers and incessantly introducing improvements and totally new products. We set

OFFER



the bar very high, but we nevertheless keep pushing the boundaries every year in terms of quality, reliability, ergonomics, and comfort of work with our tools.

In the latest catalogue, you will find products that are suitable for a wide range of applications and meet the expectations of many user groups, from amateur DIY enthusiasts to professionals working in renovation or at construction sites on a daily basis. To make it easier to choose, we divided our extensive range clearly into the following categories: Power Tools and Power Tool Accessories, Basic Tools, Connection Tools, Mechanical Tools and Automotive Articles, Measuring Tools, Building Tools and

Tool Transport Accessories, and Cutting Tools. After more than thirty years of uninterrupted presence on the market, we enjoy not only the fully deserved trust of a huge group of regular customers who keep coming back to us, but also steadily growing interest on the part of new ones, representing yet another generation of enthusiasts and experts who can appreciate high-quality tools. It is clear that world is changing, but certain things, such as durability, reliability, and safety of use, are not losing, but actually gaining in value. This is the case especially when the manufacturer is capable of expanding traditional solutions by adding an appropriate portion of significant innovations

– this is, after all, one of the main driving forces behind Modeco Expert.

We are absolutely certain that the robustness of any modern brand is measured also by its comprehensive approach to the range offered, in which the product is almost as important as the service associated with it. We are therefore delighted to remind you that you can count on the knowledge, experience and skills of our indispensable sales representatives and service technicians at all times. Meanwhile, you are most welcome to read our latest catalogue and find out more about the current offering.

The Modeco Expert Team

POWERTOOLS

The Modeco Expert power tools portfolio is designed for a wide range of users. These devices meet the expectations of both beginners and advanced DIYers, offering best-in-class performance on a daily basis.

The design of the Modeco Expert power tools is based on proven technical solutions combined with great attention to technical inspection at every stage of production. Good concept and use of top-quality materials along with meticulous quality control guarantee failure-free operation and user satisfaction. The Modeco Expert brand also provides the customers with after-sales service according to the highest standards. In the warranty period, the Modeco Expert technical support unit ensures quick and professional troubleshooting and elimination of defects. Once the warranty period lapses, the Modeco Expert technical support services make sure that spare parts are available for all models currently on the offering, but also for discontinued equipment. We also provide technical advice and assistance in choosing the right spares for our products. One of the most attractive lines of the Modeco Expert power tools is the 18V Modeco System family of battery-powered devices, offering users a wide range of diversified equipment powered by one type of 18V Li-ION battery. They are characterised by state-of-the-art solutions, high performance, and impressive durability.





IMPACT DRILLS ELECTRIC MIXERS

The Modeco Expert drills and stirrers are proven designs offering parameters tailored to the needs of demanding users, including DIYers, installers, carpenters, electricians, bricklayers, and tile setters.

The drills are intended for both non-percussion drilling in metal, wood, and plastics, and percussion drilling in materials such as lightweight concrete, masonry, brick, and stone. Stirrers, on the other hand, provide the support you need when mixing mortar, paint, and plaster. The high quality of the components used in the products of this family guarantees their reliability.

A product that stands out in the Modeco Expert offering is the MN-90-035 850W universal hammer drill. Its main advantages include the aluminium body, which increases the device's durability and improves heat dissipation, and the 1.5–13mm drill chuck, allowing you to use a wide range of drills and matching accessories.

▶ **RIGHT/LEFT ROTATION CHANGE** making it possible to remove drill bits as well as screws and bolts from materials more easily

3 METRES LONG CABLE ◀ providing the operator with freedom to work without having to carry the power source



ALUMINIUM BODY ◀ for improved tool durability and heat dissipation

▶ **ROTATIONAL SPEED CONTROL** allowing you to adjust the tool's parameters to the job at hand

▶ **SIDE HANDLE CONNECTING PIECE MADE OF METAL**, enabling you to apply greater force to the material being drilled in thanks to increased material strength

index		5906675
	pcs	
MN-90-031	1	390444



drilling
hammer drilling
left/right
rotation switch
speed control

Accessories:
chuck key
side handle
depth limiter

Power	600 W
chuck type	1,5-13 mm
rotation speed	0-3 000 /min
impact frequency	48 000 /min
drilling capacity:	
wood	max. ø25 mm
metal	max. ø10 mm
concrete	max. ø13 mm

IMPACT DRILL 600W



POWER TOOLS

index		5906675
	pcs	
MN-90-032	1	390468



drilling
hammer drilling
keyless drill chuck
left/right
rotation switch
speed control

Accessories:
side handle
depth limiter
plastic case

Power	600 W
chuck type	1,5-13 mm
rotation speed	0-3 000 /min
impact frequency	48 000 /min
drilling capacity:	
wood	max. ø25 mm
metal	max. ø10 mm
concrete	max. ø13 mm

IMPACT DRILL 600W



index		5906675
	pcs	
MN-90-033	1	390475



drilling
hammer drilling
left/right
rotation switch
speed control

Accessories:
chuck key
side handle
depth limiter

Power	710 W
chuck type	1,5-13 mm
rotation speed	0-3 000 /min
impact frequency	48 000 /min
drilling capacity:	
wood	max. ø25 mm
metal	max. ø10 mm
concrete	max. ø13 mm

IMPACT DRILL 710W



IMPACT DRILL 800W



index		5906675
	pcs	
MN-90-034	1	390482



drilling
hammer drilling
left/right
rotation switch
speed control

Accessories:
chuck key
side handle
depth limiter

Power	800 W
chuck type	1,5-13 mm
rotation speed	0-3 000 /min
impact frequency	48 000 /min
drilling capacity:	
wood	max. ø30 mm
metal	max. ø13 mm
concrete	max. ø13 mm

IMPACT DRILL 850W



index		5906675
	pcs	
MN-90-035	1	390499



drilling
hammer drilling
left/right
rotation switch
speed control

Accessories:
chuck key
side handle
depth limiter

Power	850 W
chuck type	1,5-13 mm
rotation speed	0-3 000 /min
impact frequency	48 000 /min
drilling capacity:	
wood	max. ø30 mm
metal	max. ø13 mm
concrete	max. ø13 mm

MIXER 850W



index		5906675
	pcs	
MN-90-104	1	076935



speed control
metal body

Accessories:
mixing paddle
wrench set

Power	850 W
mixing paddle diameter	max. ø120 mm
mixing paddle fixing	M14x2
rotation speed:	0-500 /min.
cord length	3 m

index		5906675
	pcs	
MN-90-105	1	076942



speed control
2 gears
metal body

Accessories:
mixing paddle
wrench set

Power	1 400 W
mixing paddle diameter	ø140 mm
mixing paddle fixing	M14
rotation speed:	
I gear	0-480 /min.
II gear	0-800 /min.
cord length	3 m

index		5906675
	pcs	
MN-90-107	1	076959



speed control
2 gears
2 stirring paddles
metal body

Accessories:
2 mixing paddle

Power	1 600 W
mixing paddle diameter	2x ø120 mm
mixing paddle fixing	HEX13
rotation speed:	
I gear	200-480 /min.
II gear	250-680 /min.
cord length	3 m

MIXER 1400W



MIXER 1600W



HAMMER DRILLS

Drilling in hard construction materials requires adequate power tools. The Modeco Expert brand delivers a range of modern SDS-Plus rotary hammers for demanding users. The high performance of the hammer mechanisms we use and the quality of workmanship will satisfy demanding DIYers and craftsmen.

Among the most popular solutions from Modeco Expert is the MN-90-222 800W SDS-plus rotary hammer. It is suitable for a wide range of applications thanks to its replaceable chuck. Featuring an electro-pneumatic impactor, it ensures high energy of the drill bit impact which translates into increased drilling speed. Another advantage of the rotary hammer is a feature which allows you to unlock the chisel position in the chuck and so adjust the chisel working angle.

▶ **FOUR OPERATING MODES (DRILLING, HAMMER DRILLING, CHISELING AND TILE REMOVAL, CHISEL ROTATION)** for versatile power tool application

▶ **CONVENIENT QUICK CHUCK CHANGE SYSTEM** allowing you to use cylindrical drill bits



ROTATIONAL SPEED CONTROL ◀ allowing you to adjust the tool's parameters to the job at hand

RUBBER CABLE INSULATION ◀ for improved mechanical damage resistance, meaning longer service life

index		5906675
	pcs	
MN-90-211	1	158532



drilling
hammer drilling
chiseling
left/right rotation switch
speed control

Accessories:
keyless drill chuck
side handle
depth limiter
3 drill bits SDS-Plus
2 chisels SDS-Plus
carrying case

Power	620 W
chuck's type:	SDS-Plus, 13 mm
drilling capacity:	
wood	max. ø30 mm
steel	max. ø13 mm
concrete	max. ø22 mm
rotation speed	0-1 250/min.
impact energy	2,1 J
impact frequency	0-5 200/min.
cord length	2 m

SDS-PLUS HAMMER DRILL 620W



POWER TOOLS

index		5906757
	pcs	
MN-90-221	1	001268



drilling
hammer drilling
chiseling
left/right rotation switch
speed control

Accessories:
side handle
depth limiter
carrying case

Power	800 W
chuck's type:	SDS-Plus
drilling capacity:	
wood	max. ø30 mm
steel	max. ø13 mm
concrete	max. ø26 mm
rotation speed	0 - 1 350/min.
Impact energy	2,8 J
impact frequency	0-5 600/min.
cord length	3 m

SDS-PLUS HAMMER DRILL 800W



index		5906757
	pcs	
MN-90-222	1	001275



drilling
hammer drilling
chiseling
left/right rotation switch
speed control

Accessories:
keyless drill chuck
side handle
depth limiter
3 drill bits SDS-Plus
2 chisels SDS-Plus
carrying case

Power	800 W
chucks:	SDS-Plus, 13 mm
drilling capacity:	
wood	max. ø30 mm
steel	max. ø13 mm
concrete	max. ø26 mm
rotation speed	0-1 350/min.
impact energy	2,8 J
impact rate	0-5 600/min.
cord length	3 m

SDS-PLUS HAMMER DRILL 800W



SDS-PLUS HAMMER DRILL 900W



index		5906757
	pcs	
MN-90-223	1	001282



drilling
hammer drilling
chiseling
left/right rotation switch
speed control

Accessories:
side handle
depth limiter
3 drill bits SDS-Plus
2 chisels SDS-Plus
carrying case

Power	900 W
chuck's type:	SDS-Plus
drilling capacity:	
wood	max. ø30 mm
steel	max. ø13 mm
concrete	max. ø30 mm
rotation speed	0-1 100/min.
Impact energy	3,2 J
impact frequency	0-5 300/min.
cord length	3 m

SDS-PLUS HAMMER DRILL 900W



index		5906757
	pcs	
MN-90-252	1	7000537



drilling
hammer drilling
chiseling

Accessories:
additional key chuck
through SDS-Plus system
spare brushes
side handle
depth limiter
2 chisels
3 drill bits SDS-Plus
grease for SDS-Plus bits
carrying case

Power	900 W
chuck capacity	SDS-Plus
drilling capacity:	
wood	max. ø40 mm
steel	max. ø13 mm
concrete	max. ø26 mm
speed	880 obr./min.
impact energy	4,2 J
impact rate	4 300/min
cord length	3 m

CORDLESS POWER TOOLS



Cordless Devices solutions are growing in popularity among power tool users. To meet the expectations of DIYers, Modeco Expert offers a wide range of power tools powered by lithium-ion batteries. The all new Modeco System 18V LI-ION line comprises a wide selection of state-of-the-art power tools while ensuring full compatibility of batteries and chargers.

The 18V LI-ION Modeco System guarantees quality and durability of the power tools and allows you to save money at the same time. What the system also stands for is an impressive diversity of configurations and the users' capacity to define the tool's technical parameters – they can easily choose the right power tool and equip it with the selected battery pack and charger of their choice.



CORDLESS TOOL SET 12V LI-ION



index		5906675
	pcs	
MN-91-501	1	028170



screwdriving
drilling
cutting
polishing
scraping
left/right
LED light

Accessories:
combi drill
multitool
Flashlight LED
2 batteries 12V, 1.5Ah
case

Battery	Li-Ion 12 V
battery charging time	1 h
chuck capacity	0,8-10 mm
drilling capacity:	
wood	max. ø16 mm
metal	max. ø6 mm
oscillations	2 700-16 000/min.
light output	100 lm

18V LI-ION BATTERY



index		5906757
	pcs	
MN-91-130	1	001466

LI-ION 18 V
MODECO SYSTEM

compatible with MODECO SYSTEM 18V
fast charging
battery level indicator

Battery	Li-Ion
Voltage	18 V
Capacity [Ah]	1,5 Ah
Capacity [Wh]	27 Wh
Charging time	30 min
Net weight	0,38 kg

18V LI-ION BATTERY



index		5906757
	pcs	
MN-91-131	1	001473

LI-ION 18 V
MODECO SYSTEM

compatible with MODECO SYSTEM 18V
fast charging
battery level indicator

Battery	Li-Ion
voltage	18 V
capacity [Ah]	2,0 Ah
capacity [Wh]	36 Wh
charging time	45 min
net weight	0,38 kg

index		5906757
	pcs	
MN-91-132	1	001480

LI-ION 18 V
MODECO SYSTEM

compatible with MODECO SYSTEM 18V
fast charging
battery level indicator

Battery	Li-Ion
voltage	18 V
capacity [Ah]	3,0 Ah
capacity [Wh]	54 Wh
charging time	65 min
net weight	0,6 kg

18V LI-ION BATTERY



index		5906757
	pcs	
MN-91-133	1	001497

LI-ION 18 V
MODECO SYSTEM

compatible with MODECO SYSTEM 18V
fast charging
battery level indicator

Battery	Li-Ion
voltage	18 V
capacity [Ah]	4,0 Ah
capacity [Wh]	72 Wh
charging time	90 min
net weight	0,6 kg

18V LI-ION BATTERY



index		5906757
	pcs	
MN-91-134	1	001503

LI-ION 18 V
MODECO SYSTEM

compatible with MODECO SYSTEM 18V
fast charging
electronic control charging process

supply voltage	230 V
charging current	4,0 A
charging time:	
battery 1,5 Ah	20 min
battery 2,0 Ah	30 min
battery 3,0 Ah	40 min
battery 4,0 Ah	55 min
net weight	0,65 kg

18V BATTERY CHARGER



NEW

index		5906757
	pcs	
MN-91-135	1	001510

LI-ION 18 V
MODECO SYSTEM

compatible with MODECO SYSTEM 18V
fast charging
electronic control charging process

supply voltage	230 V
charging current	2,4 A
charging time:	
battery 1,5 Ah	30 min.
battery 2,0 Ah	45 min.
battery 3,0 Ah	65 min.
battery 4,0 Ah	90 min.
net weight	0,4 kg

18V BATTERY CHARGER



18V DRILL / DRIVER



index		5906757
	pcs	
MN-91-136	1	001527

LI-ION 18 V
MODECO SYSTEM

compatible with MODECO SYSTEM 18V
two-speed gearbox
single sleeve chuck
fast battery charging

Equipment:
battery 1,5Ah
fast charger 2,4A
accessories
transport case

battery voltage	18 V
battery capacity	1,5 Ah
charging time	30 min.
number of batteries	1
max. torque	22 Nm
chuck capacity	1-10 mm
rotation speed:	
I gear	0-350 obr/min
II gear	0-1 300 obr/min
drilling diameter:	
wood	max. 20 mm
metal	max. 6 mm

18V DRILL / DRIVER



index		5906757
	pcs	
MN-91-137	1	001534

LI-ION 18 V
MODECO SYSTEM

compatible with MODECO SYSTEM 18V
two-speed gearbox
single sleeve chuck
fast battery charging

Equipment:
2 batteries 2,0Ah
fast charger 2,4A
accessories
transport case

battery voltage	18 V
battery capacity	2,0 Ah
charging time	45 min.
number of batteries	2
max. torque	40 Nm
chuck capacity	1-13 mm
rotation speed:	
I gear	0-450 obr/min
II gear	0-1 600 obr/min
drilling diameter:	
wood	max. 22 mm
metal	max. 10 mm

18V DRILL / DRIVER WITH IMPACT



index		5906757
	pcs	
MN-91-138	1	001541

LI-ION 18 V
MODECO SYSTEM

compatible with MODECO SYSTEM 18V
two-speed gearbox
single sleeve chuck
fast battery charging
hammer drilling function

Equipment:
2 batteries 2,0Ah
fast charger 2,4A
accessories
transport case

battery voltage	18 V
battery capacity	2,0 Ah
charging time	45 min.
number of batteries	2
max. torque	40 Nm
chuck capacity	1-13 mm
rotation speed :	
I gear	0-450 obr/min
II gear	0-1 600 obr/min
drilling diameter :	
wood	max. 22 mm
metal	max. 10 mm
concrete	max. 10 mm

index		5906675
	pcs	
MN-91-148	1	456362

LI-ION 18 V
MODECO SYSTEM

compatible with MODECO SYSTEM 18V
two-speed gearbox
single sleeve chuck

Equipment:
without battery
and charger

voltage	18 V
max. torque	28 Nm
chuck capacity	1-10 mm
rotation speed:	
I gear	0-400 obr/min
II gear	0-1350 obr/min
drilling diameter:	
wood	max. 20 mm
metal	max. 6 mm

18V DRILL / DRIVER



NEW

POWER TOOLS

index		5906757
	pcs	
MN-91-139	1	001558

LI-ION 18 V
MODECO SYSTEM

compatible with MODECO SYSTEM 18V
tool holder 1/4" HEX
metal gear housing
without battery and charger

voltage	18 V
max. torque	180 Nm
tool holder	1/4" HEX
rotation speed	0-2 800 obr/min
impact frequency	0-3 600/min
max. size of bolt	M12

18V IMPACT DRIVER



index		5906757
	pcs	
MN-91-140	1	001565

LI-ION 18 V
MODECO SYSTEM

compatible with MODECO SYSTEM 18 V
tool holder 1/2"
metal gear housing
without battery and charger

voltage	18 V
max. torque	350 Nm
tool holder	1/2"
rotation speed	0-2 300 obr/min
impact frequency	0-3 300/min
max. size of bolt	M16

18V IMPACT WRENCH



18V HAMMER DRILL SDS-PLUS



index		5906757
	pcs	
MN-91-141	1	001572

LI-ION 18 V
MODECO SYSTEM

compatible with MODECO SYSTEM 18V
tool holder SDS-plus
drilling
hammer drilling
rotations left/right
without battery and charger

voltage	18 V
chuck's type	SDS-Plus
impact energy	0,9 J
impact frequency	0-4 300/min
rotation speed	0-900 obr/min
drilling diameter:	
concrete	max. 10 mm
wood	max. 20 mm
metal	max. 10 mm

18V HAMMER DRILL SDS-PLUS



index		5906757
	pcs	
MN-91-142	1	001589

LI-ION 18 V
MODECO SYSTEM

compatible with MODECO SYSTEM 18V
tool holder SDS-plus
two-speed gearbox
drilling
hammer drilling
rotations left/right
without battery and charger

voltage	18 V
chuck's type	SDS-Plus
impact energy	1,2 J
impact frequency	0-5 000/min
rotation speed	
I gear	0-300 obr/min
II gear	0-1 000 obr/min
drilling diameter:	
concrete	max. 10 mm
wood	max. 20 mm
metal	max. 10 mm

18V ANGLE GRINDER



index		5906757
	pcs	
MN-91-143	1	001596

LI-ION 18 V
MODECO SYSTEM

compatible with MODECO SYSTEM 18V
tool-free adjustment disc cover
side handle mounted in 3 positions
key pocket mounted
in the handle
without battery and charger

voltage	18 V
disc diameter	115 mm
inner disc diameter	22,2 mm
rotation speed	8 000/min

index		5906757
	pcs	
MN-91-144	1	001602

LI-ION 18 V
MODECO SYSTEM

compatible with MODECO SYSTEM 18V
saw tilt adjustment up to 50°
adjusting the cutting depth
parallel guide
24-tooth circular saw blade
without battery and charger

voltage	18 V
saw blade diameter	165 mm
blade bore diameter	16 mm
rotation speed	3 800/min
max. cutting depth:	
angle 90°	50 mm
angle 45°	35 mm

18V CIRCULAR SAW



index		5906757
	pcs	
MN-91-146	1	001626

LI-ION 18 V
MODECO SYSTEM

compatible with MODECO SYSTEM 18V
base tilt adjustment up to 45°
keyless base adjustment
stroke speed control
quick blade change
pendulum action
parallel guide
without battery and charger

voltage	18 V
blade holder type	typ „T“
stroke frequency	0-2400/min
stroke length	25,4 mm
max. cutting depth:	
wood	80 mm
metal	6 mm

JIGSAW 18V



index		5906757
	pcs	
MN-91-147	1	001633

LI-ION 18 V
MODECO SYSTEM

compatible with MODECO SYSTEM 18V
quick blade change
stroke speed control
keyless base adjustment
pendulum action
without battery and charger

voltage	18 V
stroke frequency	0-2 400/min
stroke length	20 mm
max. cutting depth:	
wood	150 mm
metal	5 mm

RECIPROCATING SAW 18V



TOOL BAG



index	①	📦	📦	5906757
	mm	pcs	pcs	
MN-03-460	610x300x280	1	10	910287

LI-ION 18 V
MODECO SYSTEM

POLYESTER
600

27
POCKETS



compatible with MODECO SYSTEM 18V
made of strong polyester
reinforced seams
27 durable pockets
shoulder strap
zip closure

TOOL BAG



index	①	📦	📦	5906757
	mm	pcs	pcs	
MN-03-464	460x280x300	1	10	910294

LI-ION 18 V
MODECO SYSTEM

POLYESTER
600

30
POCKETS



compatible with MODECO SYSTEM 18V
made of strong polyester
reinforced seams
30 durable pockets
shoulder strap
zip closure
stiffened bottom

TOOL BAG



index	①	📦	📦	5906757
	mm	pcs	pcs	
MN-03-466	500x230x280	1	4	910300

LI-ION 18 V
MODECO SYSTEM

POLYESTER
600

23
POCKETS



compatible with MODECO SYSTEM 18V
made of strong polyester
reinforced seams
23 durable pockets
shoulder strap
metal handle



POWERTOOLS



ANGLE GRINDERS



Angle grinders – representing one of the most popular groups of power tools on our market – are subject to demanding strength tests. The models delivered by Modeco Expert are designed to ensure robustness and reliability, without compromising cost-effectiveness at the same time. This means that they are perfect solutions for demanding DIYers and craftsmen looking for ergonomic products of good quality.

This group of power tools includes the versatile 1200W two-hand angle grinder matching 125mm discs with a speed control feature, designed for more demanding and prolonged applications. It has the advantage of an ergonomic two-hand construction with a rubberised anti-slip handle for improved comfort and safety.

▶ **3-POSITION SIDE HANDLE**
providing more secure grip, increased safety, and improved ergonomics as well as working precision

3 METRES LONG CABLE ◀
providing the operator with freedom to work without having to carry the power source

ERGONOMIC DESIGN ◀
with safety switch to prevent accidental start-up

ROTATIONAL SPEED CONTROL allowing ◀
you to adjust the tool's parameters to the job at hand

KEYLESS GUARD ATTACHMENT ◀
for quick position change without additional tools



ANGLE GRINDERS 600W



index		5906675
		pcs
MN-93-035	1	345079

CE

chuck lock
3 position mounted
side handle

Accessories:
fork spanner
side handle

Power	600 W
disc diameter	ø115 mm
blade bore	ø22.2 mm
speed	12 000 obr./min.
cord length	3 m

ANGLE GRINDERS 750W



index		5906675
		pcs
MN-93-036	1	345086

CE

chuck lock
keyless guard
3 position mounted side handle
Soft Start - gentle
increase of speed at
start-up

Accessories:
fork spanner
side handle

Power	750 W
disc diameter	ø125 mm
blade bore	ø22.2 mm
speed	12 000 obr./min.
cord length	3 m

ANGLE GRINDERS 850W



index		5906675
		pcs
MN-93-037	1	345093

CE

chuck lock
keyless guard
3 position mounted side handle
Soft Start - gentle
increase of speed at
start-up

Accessories:
fork spanner
side handle

Power	850 W
disc diameter	ø125 mm
blade bore	ø22.2 mm
speed	12 000 obr./min.
cord length	3 m

index		590675
	pcs	
MN-93-022	1	7907447



chuck lock
keyless guard
3 position mounted side handle

Accessories:
fork spanner
side handle
spare brushes

Power	900 W
disc diameter	ø125 mm
blade bore	ø22.2 mm
speed	12 000 obr./min.
cord length	3 m

index		5906675
	pcs	
MN-93-038	1	345109



speed control
easy brushes change
chuck lock
keyless guard
easy access to brushes
3 position mounted side handle
Soft Start - gentle increase of speed at start-up

Accessories:
fork spanner
side handle
spare brushes

Power	1 200 W
disc diameter	ø125 mm
blade bore	ø22.2 mm
speed	4 000-12 000 obr./min.
cord length	3 m

index		5906675
	pcs	
MN-93-034	1	027401



rotating rear handle
speed control
Soft Start - gentle increase of speed at start-up

Accessories:
fork spanner
side handle
spare brushes

Power	1 200 W
disc diameter	ø125 mm
blade bore	ø22.2 mm
speed	3 000-11 000 obr./min.
cord length	3 m

ANGLE GRINDERS 900W



POWER TOOLS

ANGLE GRINDERS 1200W



ANGLE GRINDERS 1200W



ANGLE GRINDERS 2300W



index		590675
	pcs	
MN-93-011	1	7901650



chuck lock
Soft Start - gentle increase of speed at start-up
rotating rear handle
keyless guard
3 position mounted side handle

Accessories:
fork spanner
side handle
spare brushes

Power	2 300 W
disc diameter	ø230 mm
blade bore	ø22.2 mm
speed	6 200 obr./min.
cord length	3 m

ANGLE GRINDERS 2350W



index		5906675
	pcs	
MN-93-039	1	345116



chuck lock
Soft Start - gentle increase of speed at start-up
keyless guard
3 position mounted side handle

Accessories:
fork spanner
side handle
spare brushes

Power	2 350 W
disc diameter	ø230 mm
blade bore	ø22.2 mm
speed	6 500 obr./min.
cord length	3 m

FINISHING WORK



Modeco Expert provides systems intended for sanding of gypsum finish plaster. These products are designed specifically for gypsum drywall working. Our selection of rotary sanders comprises products for sanding of wall and ceiling surfaces as well as corners. The Modeco Expert vacuum cleaner for gypsum dust, on the other hand, is characterised by a compact design and high resistance to the harmful effects of gypsum dust.

A product which clearly stands out in our portfolio is the MN-93-225 600W giraffe-type drywall sander. Its definite advantage is the possibility of adjusting the handle length (1100 - 1650 mm) which makes sanding of ceilings and walls otherwise beyond the operator's reach convenient and safe. It is also important that the sander features a disc speed control system which allows you to adjust its working speed to the substrate and the job specificity. Additionally, the design of the hinged and motorised sanding disc unit allows the disc to evenly adhere to the material being sanded.



LOWER HANDLE that can be hooked onto a tool belt while work is conducted, freeing the operator's hands, which significantly reduces work fatigue

4-METRE POWER CABLE significantly expanding the working area without moving the power source

CIRCUMFERENTIAL SANDING DISC BRUSH preventing dust from escaping and reducing damage to the surface being sanded

▶ **FOLDING SANDER BODY AND ATTACHED TRANSPORT CASE** for convenient and safe handling and storage

▶ **DUST EXTRACTION SYSTEM** ensuring reduced dustiness inside the room and better working conditions once connected with a vacuum cleaner via an attached tube



DRYWALL SANDER 1220W



index		5906675
		pcs
MN-93-220	1	076928



speed control
2 position mounted side handle
shoulder strap
pulled off front part of the casing for grinding the corners of the walls
suction of dust with
power adjustment

Accessories:
set of sand papers
side handle and shoulder strap
dust bag with hose
wrench

Power	1 220 W
disc diameter	ø215 mm
diameter of paper	ø215-225 mm
diameter of pipe	ø 32 mm
speed	1 500-2 300 obr./min.
cord length	4 m

DRYWALL SANDER 600W



index		5906675
		pcs
MN-93-225	1	076911



length adjustment
speed control
folding
hose for vacuum cleaner

Accessories:
set of sand papers
suction hose for vacuum cleaner with reductions
wrench carrying case

Power	600 W
disc diameter	ø215 mm
diameter of paper	ø215-225 mm
diameter of pipe	ø32 mm
speed	600-1 500 obr./min.
total length	1 100-1 650 mm
cord length	4 m

VACUUM CLEANER FOR GYPSUM DUST



index		5906675
		pcs
MN-94-153	1	454986



dedicated to cooperation with a gypsum finish grinder
automatic filter cleaning
vacuum cleaner resistant to gypsum dust
washable filter
bagless vacuum cleaner
wet and dry work
power socket for power tool connections

Equipment:
flexible suction hose 3m
telescopic suction pipe
floor nozzle
multifunctional nozzle
power tool adapter
washable filter

Power	1400 W
tank capacity	18 l
air flow	34 l/s
underpressure	18,5 kPa
length of hose	3 m
cord length	6 m

index		5906757
		pcs
MN-92-304	1	274419



0-45° table tilt
stainless steel table

Accessories:
template for 45° cut

Power	450 W
blade diameter	ø180 mm
blade bore	ø22,2 mm
speed	2950 obr./min.
depth of cut	35,0 mm
table size	385x395 mm
cord length	3 m

TABLE TILE SAW 450W



POWER TOOLS

HEAT GUNS, SOLDERING GUNS, GLUE GUNS

The Modeco Expert line of heat guns includes both step-adjusted tools and devices featuring advanced stepless electronic temperature and airflow control. All these models are characterised by high quality and ergonomics that cater to the users' requirements.

The Modeco Expert range of hot melt glue guns and soldering irons will meet the expectations of all those looking for an efficient tool for repair and decoration work.

They include the MN-94-009 2-speed heat gun with a capacity of 2 000W. It stands out for its 6-step parameter adjustment system, visualised by LEDs, making it possible to adapt working temperature to the job at hand. The heat gun design enables you to set it vertically as a stationary device and to handle the material with two hands.

▶ **LIGHTWEIGHT AND DURABLE BODY**

ensuring robustness and reducing fatigue at work



TWO SPEEDS allowing you to adjust working temperature in the range of 50–350°C (with 50°C increments) and in the range of 100–600°C (with 100°C increments), respectively

▶ **AIR FLOW ADJUSTABLE TO 550 L/MIN IN BOTH SPEEDS**

providing high blowing power for more efficient work

▶ **DIVERSITY OF ACCESSORIES:**

4 nozzles, spatula and scraper allowing for a wide range of works to be conducted without having to buy additional tools

index		5906675
	pcs	
MN-94-008	1	099156



2-step heat and air-flow settings

Power	2 000 W
temperature:	
level I	350°C
level II	550°C
cord length	3 m

HOT AIR GUN 2000W



POWER TOOLS

index		5906675
	pcs	
MN-94-009	1	099163



2-step heat and air-flow settings
6-step temperatur settings with LED scale

Accessories:
4 exchangeable nozzle, shave hook, paint scraper, case

Power	2 000 W
temperature:	
level I	50-350 °C
level II	100-600 °C
cord length	3 m

HOT AIR GUN 2000W



index		5906675
	pcs	
MN-94-010	1	099170



2-step heat and air-flow settings
digital LCD panel
smooth airflow setting
smooth temperature setting

Accessories:
4 exchangeable nozzle, shave hook, paint scraper, case

Power	2 000 W
temperature:	
level I	50°C
level II	50-600°C
cord length	3 m

HOT AIR GUN 2000W



GLUE GUN 25 (50)W



index		5906757
	pcs	
MN-99-003	10	154629



Start power	50 W
Rated power	25 W
glue diameter	ø11-12 mm
heating time	6 min./мин.
working temperature	170°C
cord length	1,35 m

GLUE GUN 15 (80)W



index		5906757
	pcs	
MN-99-005	10	154636



Start power	65 W
Rated power	15 W
glue diameter	ø11-12 mm
heating time	7 min./мин.
working temperature	170°C
cord length	1,35 m

GLUE GUN 15 (80)W



index		5906757
	pcs	
MN-99-006	1	269163



Accessories:
10 glue sticks
carrying case

Start power	80 W
Rated power	20 W
glue diameter	ø11-12 mm
heating time	7 min./мин.
working temperature	170°C
cord length	1,35 m

index		5906757
	pcs	
MN-99-206	1	271036



spot illumination

Accessories:
interchangeable tips
solder
rosin
carrying case

Power	175 W
heating time	12 sek./sec./cek.
cooling time	48 sek./sec./cek.
working temperature	430°C
cord length	1,5 m

TRANSFORMER SOLDERING GUN 175W



POWER TOOLS

index		5906757
	pcs	
MN-99-207	1	907485



spot illumination
three-range temperature
control

Accessories:
interchangeable tips
key
solder
rosin
carrying case

Power	200 W
heating time	12 sek./sec./cek.
cooling time	48 sek./sec./cek.
working temperature	70-500 °C
cord length	1,5 m

TRANSFORMER SOLDERING GUN 200W



WOODWORKING

Cutting, sanding, planing – you can effectively perform all these operations without hassle using the Modeco Expert power tools.

Our woodworking machines will prove perfect for larger refurbishment and construction jobs as well as more precise renovation and decoration work. Workshop vacuum cleaners will help you to keep the workplace tidy while increasing its comfort and safety at the same time.

The advanced MN-92-103 800W jigsaw featuring a laser guide and cutting adjustment clearly stands out in the Modeco Expert offering. The product's main advantage is the possibility of controlling the blade working speed, which enables precise control and adjustment of the device parameters to the material being cut.

▶ **TRANSPARENT BLADE GUIDE** for high-precision jigsaw handling in the material combined with user protection against splinters

BLOKADA WŁĄCZNIKA ◀
umożliwia długotrwałą pracę bez konieczności trzymania wciśniętego spustu, co wpływa na komfort oraz bezpieczeństwo pracy



▶ **LASER CUTTING LINE GUIDE** making it easy to guide the device along the desired track

index		5906675
	pcs	
MN-92-014	1	306872



45° base tilt
steel base
parallel guide

Accessories:
185 mm carbide disk blade
guide

Power	1 200 W
RPM	4 700 obr./min.
depth of cut at 90°	0-65 mm
tilting	0-45°
blade diameter	ø185 mm
blade bore	ø20 mm
cord length	3 m

CIRCULAR SAW 1200W



POWER TOOLS

index		5906675
	pcs	
MN-92-015	1	306957



45° base tilt
aluminium base
parallel guide
laser guide

Accessories:
185 mm carbide disk blade
guide

Power	1 500 W
RPM	4 700 obr./min.
depth of cut at 90°	0-63 mm
tilting	0-45°
blade diameter	ø185 mm
blade bore	ø20 mm
cord length	3 m

CIRCULAR SAW 1500W



index		5906675
	pcs	
MN-92-101	1	306155



± 45° base tilt
speed control
vacuum cleaner
connection

Accessories:
blade
guide

Power	400 W
blade	typ "T"
stroke rate	0-3000 /min
stroke length	18 mm
cutting degree	0-45°
cutting depth:	
wood	
metal	55 mm
aluminium	6 mm
cord length	6 mm
cord length	3 m

JIGSAW 400W



JIGSAW 570W



index		5906675
		pcs
MN-92-102	1	306407



± 45° base tilt
speed control
undercut adjustment
keyless blade change
vacuum cleaner connection

Power	570 W
blade	typ "T"
stroke rate	0-3 000 /min
stroke length	19 mm
cutting degree	0-45°
cutting depth:	
wood	
metal	65 mm
aluminium	8 mm
cord length	8 mm
cord length	3 m

JIGSAW 800W



index		5906675
		pcs
MN-92-103	1	306452



± 45° base tilt
speed control
undercut adjustment
keyless blade change
laser guide
vacuum cleaner connection

Power	800 W
blade	typ "T"
stroke rate	0-3 000/min.
stroke length	19 mm
cutting degree	0-45°
cutting depth:	
wood	
metal	80 mm
aluminium	10 mm
cord length	10 mm
cord length	3 m

SABRE SAW 800W



index		5906675
		pcs
MN-92-501	1	028132



Accessories:
blade

quick blade change
rotatable handle
LED light
keyless base adjustment

Power	800 W
stroke rate	0-2 800/min.
stroke length	28 mm
cutting depth:	
wood	150 mm
plastic	105 mm
aluminium	6 mm
steel	5 mm
cord length	3 m

index		5906675
	pcs	
MN-92-091	1	329178



cutting
polishing
scraping
oscillation

Accessories:
straight blade for metal cutting
round blade for wood cutting
scraper
polishing base
sanding paper (3 pcs)
dust extraction adapter
key
case

Power	300 W
oscillations	10 000-18 500/min.
cord length	3 m

MULTITOOL 300W



POWER TOOLS

index		590675
	pcs	
MN-93-210	1	7910355



aluminium base aluminium base алюминиевое основание

Accessories: dust collector **Accessories:** dust collector **Принадлежности:** емкость для пыли

Power	300 W
pad size	115x230 mm
oscillations per minute	12 000/min.
oscillation travel	2 mm
cord length	3 m

FINISHING SANDER 300W



index		590675
	pcs	
MN-93-215	1	7910386



speed control
adjustable handle

Accessories:
dust collector
abrasive paper disk

Power	430 W
backing pad size	ø125 mm
speed	6 000-13 000 obr./min.
oscillation travel	2 mm
cord length	3 m

RANDOM ORBIT SANDER 430W



BELT SANDER 800W



index		5906675
		pcs
MN-93-307	1	135885



Accessories:
dust collector
sanding belt
spare brushes

Power	800 W
belt speed	120-260 m/min.
sanding area	76x146 mm
belt dimensions	76x457 mm

PLANER 900W



index		5906757
		pcs
MN-92-207	1	910409



chiseling depth limiter
chiseling depth adjustment
edge slot
aluminium base

Accessories:
spare brushes

Power	900 W
planer width	82 mm
depth of cut	0-3,0 mm
speed	16 000 obr. /min.
cord length	3 m

VACUUM CLEANER 18L 1200W



index		5906675
		pcs
MN-94-151	1	383569



wet/dry
air outflow

Accessories:
suction hose
2 matching tubes
universal nozzle
flat nozzle
round nozzle
filter HEPA
dust bag

Power	1 200 W
capacity	18 l
intake airflow	1.75±0.1 m ³ /min
pressure	16±1.5 Kpa
rotation	2,5 m
cord length	5,2 m
dedicated dust bag	MN-94-193

index		5906675
		pcs
MN-94-152	1	383576



wet/dry
electric socket
air outflow

Accessories:

suction hose
2 matching tubes
Universal nozzle
flat nozzle
round nozzle
filter HEPA
dust bag

Power	1200 W
capacity	30 l
intake airflow	1.8±0.1 m ³ /min
pressure	17±1.5 Kpa
rotation	3 m
cord length	6 m
dedicated dust bag	MN-94-201

VACUUM CLEANER 30L 1200W



POWER TOOLS

index		5906675
		pcs
MN-94-153	1	454986



dedicated to cooperation with a
gypsum finish grinder
automatic filter cleaning
vacuum cleaner resistant
to gypsum dust
washable filter
bagless vacuum cleaner
wet and dry work
power socket for
power tool connections

Equipment:

flexible suction hose 3 m
telescopic suction pipe
floor nozzle
multifunctional nozzle
power tool adapter
washable filter

power	1400 W
tank capacity	18 l
air flow	34 l/s
underpressure	18,5 kPa
length of hose	3 m
cord length	6 m

VACUUM CLEANER FOR GYPSUM DUST



OTHER POWER TOOLS

The supplementary products from Modeco Expert include both highly specialised and universal devices that can be used for renovation work, at workshops or at home by DIYers.

One of such products is the MN-92-405 380W shears for metal sheets. Their advantage is the switch lock which allows you to work for a long time without having to hold the trigger pressed, which affects the comfort and safety of use. The tool's special design lets you quickly cut corrugated and box profile metal sheets in different directions.

▶ **METAL BODY** increasing tool's durability and improving heat dissipation

3-METRE LONG CABLE ◀
providing the operator with freedom to work without having to carry the power source



SWITCH LOCK to let you work for prolonged periods without having to hold the trigger, improving the comfort and safety of use ◀

SPECIAL DESIGN for quick cutting of corrugated and box profile sheets in different directions ◀

index		590675
	pcs	
MN-92-405	1	7909106

CE

Accessories:
guide
cutter

Power	380 W
cutting depth: carbon steel	0,5-1,8 mm
stainless steel	0,5-1,0 mm
cord length	3 m

METAL SHEET SHEARS 380W



POWER TOOLS

index		5906675
	pcs	
MN-93-015	1	293400

CE

brushless motor
large, adjustable spark and chip
protective guards
aluminium body

brushless motor
large, adjustable spark and
chip protective guards
aluminium body

бесщеточный двигатель
большие регулируемые
экраны предохраняющие от искр и
осколков
алюминиевый корпус

Power	150 W
blade diameter	ø125 mm
blade bore	ø12,7 mm
grinding wheel width	16 mm
speed	2950 obr./min.
cord length	1,5 m

BENCH GRINDER 150W



index		5906675
	pcs	
MN-93-016	1	293417

CE

brushless motor
large, adjustable spark and chip
protective guards
aluminium body

Power	350 W
blade diameter	ø200 mm
blade bore	ø16 mm
grinding wheel width	20 mm
speed	2950 obr./min.
cord length	1,5 m

BENCH GRINDER 350W



DIRTY WATER PUMP 400W



index		5906675
	pcs	
MN-95-004	1	014739



Submersible pump designed for pumping clean and dirty water
An adjustable length float switch turns the pump on and off according to the water level
The water connection allows the connection of hoses of various diameters

Power	400 W
Max. immersion depth	5 m
Max. lifting height	5 m
Max. efficiency	7500 l/h
Min. water column height	9 cm
Max. temperature of water	35°C
Max. the size of the contamination	25 mm
Cable length	10 m

DIRTY WATER PUMP 750W



index		5906757
	pcs	
MN-95-005	1	909564



Submersible pump designed for pumping clean and dirty water
An adjustable length float switch turns the pump on and off according to the water level
The water connection allows the connection of hoses of various diameters

Power	750 W
Max. immersion depth	7 m
Max. lifting height	9 m
Max. efficiency	13 000 l/h
Min. water column height	9 cm
Max. temperature of water	35°C
Max. the size of the contamination	25 mm
Cable length	10 m

DIRTY WATER PUMP 1100W



index		5906675
	pcs	
MN-95-006	1	014746



Submersible pump designed for pumping clean and dirty water

An adjustable length float switch turns the pump on and off according to the water level

The water connection allows the connection of hoses of various diameters

Submersible pump designed for pumping clean and dirty water

An adjustable length float switch turns the pump on and off according to the water level

The water connection allows the connection of hoses of various diameters

Погружной насос предназначен для перекачивания чистой и грязной воды.

Поплавковый выключатель с регулируемой длиной включает и выключает насос в зависимости от уровня воды.

Подключение воды позволяет подключать шланги различного диаметра.

Power	1100 W
Max. immersion depth	7 m
Max. lifting height	11 m
Max. efficiency	15 500 l/h
Min. water column height	9 cm
Max. temperature of water	35°C
Max. the size of the contamination	25 mm
Cable length	10 m

index		5906675
	pcs	
MN-99-921	1	022079



For indoor use

cable length	10 m
cable profile	3x1,5 mm ²
max power of connected devices	
expanded cable	3 000 W
retracted cable	1 000 W

REEL EXTENSION CORD 10M



index		5906675
	pcs	
MN-99-922	1	022093



For indoor and outdoor use

cable length	25 m
cable profile:	3x1,5 mm ²
max power of connected devices:	
expanded cable	3 000 W
retracted cable	1 000 W

REEL EXTENSION CORD 25M



Power tools are relevant to both professionals and do-it-yourselfers, yet without properly fitted power tool accessories they cannot perform as expected.

POWER TOOL ACCESSORIES

That is why Modeco Expert have made sure that every user of the brand's power tools has also access to the necessary accessories. To meet the customers' requirements, the brand has created a series of bits, sockets and adapters. The offering includes PZ, PH, TORX, and HEX bits made of high quality S2 steel of hardness ranging at 56–62 HRC.

Modeco Expert also offers coated abrasive accessories, grinding discs, as well as corundum and diamond grinding wheels. Additionally, our portfolio has been extended with product groups that include cutting, bonding and mixing products. They stand out for their high quality which guarantees high performance and durability, which are all extremely important properties in products of this type.





BITS FOR POWER SCREWDRIVERS



index	+	↔	☐	☐	☐	5906757
		mm	pcs	pcs	pcs	
MN-15-302	PH2	25	20	240	2400	271739



25MM PZ2 BITS



index	+	↔	☐	☐	☐	5906757
		mm	pcs	pcs	pcs	
MN-15-312	PZ2	25	20	240	2400	271760



25MM PH2 BITS TIN TORSION



index	+	↔	☐	☐	☐	5906757
		mm	pcs	pcs	pcs	
MN-15-402	PH2	25	20	240	2400	271821



25MM PZ2 BITS TIN TORSION

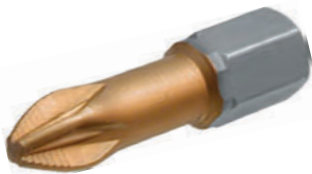

index	+	↔	☐	☐	☐	5906757
		mm	pcs	pcs	pcs	
MN-15-412	PZ2	25	20	240	2400	271838



50MM PH BITS

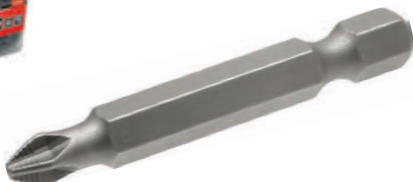

index	+	↔	☐	☐	☐	5906757
		mm	pcs	pcs	pcs	
MN-15-391	PH2	50	10	120	1200	271869



index					5906757
		mm	pcs	pcs	
MN-15-393	PH2	100	12	480	271890
MN-15-394	PH2	150	12	480	271906
MN-15-395	PH2	200	12	480	271913
MN-15-396	PH2	250	12	240	271920
MN-15-398	PH2	350	12	216	271937



LONG PH BITS



index				5906757
	pieces	sets	sets	
MN-15-501	7	12	120	271708



	mm	mm
	5,0x0,8; 6,5x1,2	25
	PH1; PH2	25
	PZ1; PZ2	25
	1/4"	60

7 PCS BIT SET



index				5906757
	pieces	sets	sets	
MN-15-502	7	12	120	271715



	mm	mm
	PH0; PH1; PH2, PH3	25
	PZ1; PZ2	25
	1/4"	60

7 PCS BIT SET



index				5906757
	pieces	sets	sets	
MN-15-511	5	12	120	271630



	mm	mm
	PH0; PH1; 2x PH2; PH3	25

5 PCS BIT SET



index				5906757
	pieces	sets	sets	
MN-15-512	5	12	120	271647



	mm	mm
	PH1; PH2; PH3	25
	PZ1; PZ2	25

5 PCS BIT SET



5 PCS BIT SET, 25 MM



index	①	📦	📦	5906757
	pieces	sets	sets	
MN-15-514	5	12	120	271661



	⌀	↔
	mm	mm
	⊕	H2; H3; H4; H5; H6
		25

5 PCS BIT SET, 25 MM



index	①	📦	📦	5906757
	pieces	sets	sets	
MN-15-515	5	12	120	271678



	⌀	↔
	mm	mm
	⊕	T10; T15; T20; T25; T30
		25

3 PCS BIT SET, 50 MM



index	①	📦	📦	5906757
	pieces	sets	sets	
MN-15-521	3	12	120	271685



	⌀	↔
	mm	mm
	⊕	PH1; PH2; PH3
		50

3 PCS BIT SET, 50 MM



index	①	📦	📦	5906757
	pieces	sets	sets	
MN-15-522	3	12	120	271692



	⌀	↔
	mm	mm
	⊕	PZ1; PZ2; PZ3
		50

PH2 BITS 25MM WITH STOP RING



index	⊕	↔	📦	📦	5906757
		mm	pcs	pcs	
MN-15-152	PH2	25	10	800	160477

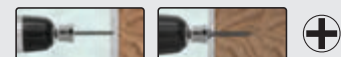

index					5906757
		mm	pcs	pcs	
MN-15-152-2	2xPH2	25	24	480	163805



2 BITS PH2 25 MM WITH STOP RING



index				5906675	
		pieces	sets	sets	
MN-15-540		32	6	24	135069

S2 STEEL

		mm	mm
		SL3, SL4, SL5	25
		2x PZ2	25
		2x PH2	25
		T10; T15; T20; T25; T27; T30; T40	25
		T10; T15; T20; T25; T27; T30; T40	25
		1/4"	60

32 PCS BIT SETS - SL, PH, PZ, TORX, 25 MM

32 PCS BIT SETS
НАБОРЫ БИТОВ ДЛЯ ОТВЕРТОК 32 ШТ



index				5906675	
		pieces	sets	sets	
MN-15-541		15	15	60	092454

S2 STEEL

		mm	mm
		SL3, SL4, SL5	25
		PZ1, PZ2, PZ3	25
		PH1; PH2; PH3	25
		T10; T15; T20; T25; T30	25
		1/4"	60

15 PCS BIT SETS - SL, PH, PZ, TORX, 25 MM



index				5906675	
		pieces	sets	sets	
MN-15-542		15	15	60	092461

S2 STEEL

		mm	mm
		PH1; PH2; PH3; PZ1; PZ2; PZ3	25
		2xPH2, PH3, 2xPZ2	50
		T10; T20; T25; T30	25

15 PCS BIT SETS - PH, PZ, TORX



index					5906757	
	mm	inch	pcs	pcs		
MN-16-007	7,0	45	1/4	20	400	132627
MN-16-008	8,0	45	1/4	20	400	113589
MN-16-010	10,0	45	1/4	20	400	113596
MN-16-013	13,0	45	1/4	20	400	113602



SOCKETS DRIVE 1/4"



SOCKETS DRIVE 1/4"



index					5906757
		inch	pcs	pcs	
MN-16-006B	6,0	1/4	24	240	272613
MN-16-008B	8,0	1/4	24	240	272637
MN-16-010B	10,0	1/4	24	240	272644
MN-16-013B	13,0	1/4	24	240	272651



BIT HOLDER



index					5906757
	mm	inch	pcs	pcs	
MN-16-105	60	1/4	24	288	160453



QUICK CHANGE BIT HOLDER



MN-16-205



MN-16-207

index					5906757
	mm	inch	pcs	pcs	
MN-16-205	50	1/4	24	240	160484
MN-16-207	75	1/4	12	288	160491



QUICK CHANGE BIT HOLDER



index					5906657
	mm	inch	pcs	pcs	
MN-16-208	65	1/4	24	240	392943



BIT HOLDER



index						5906757
		mm	mm	pcs	pcs	
MN-19-010	PH2	75	1/4	12	120	160514





index					5906675
	mm	inch	pcs	pcs	
MN-16-215	42	1/4	20	40	096971



ANGLE BIT HOLDERY - PH2 PZ2

ANGLE BIT HOLDER
УДЛИНИТЕЛЬ ДЛЯ БИТОВ



index				5906757
	pieces	pcs	pcs	
MN-62-390	5	10	100	270343



SCREW EXTRACTORS 5 PCS



DRILL BITS

Modeco Expert offers a portfolio of high-quality and durable drill bits that come in a wide range of sizes.

They can be used for drilling in steel and hard metals, concrete, stone, brick, hollow masonry units, or wood. Thanks to the variety of their applications, available sizes, as well as high quality, they can be successfully used by bricklayers, roofers, masons, fitters, and DIYers alike. Depending on the chuck type, the drill bits are intended for drills, cordless drill drivers as well as rotary hammers. The most popular products in the line are four-cutter drill bits for concrete, fitting into the SDS PLUS and SDS MAX chucks. They feature a characteristic monolithic four-cutter carbide tip that enables drilling in very hard concrete and a centring point allowing you to quickly start drilling without the bit slipping.



▶ **MONOLITHIC FOUR-CUTTER CARBIDE TIP** enabling you to drill in very hard concrete





▶ **SDS-PLUS and SDS-MAX CHUCK** ensuring that the product matches most of the rotary hammers available on the market

▶ **AUTOMATIC HARDENING AT 1200°C** that significantly increases material performance and strength

48-51 HRC HARDNESS ◀
for longer life

ADDITIONAL DRILL BIT SPIRAL GROOVE ◀
for faster extraction of drillings and increased drilling speed

DEEP-SEATED SINTERED CARBIDE ◀
element for prolonged service life



index					5906757
	mm	mm	pcs	pcs	
MN-60-230*	3,3	60	10	1000	267626
MN-60-240	4,0	75	10	1000	267657
MN-60-250	5,0	85	10	1000	267695
MN-60-260	6,0	95	10	1000	267718
MN-60-265	6,5	100	10	400	267725
MN-60-270	7,0	110	10	1000	267732
MN-60-280	8,0	115	10	1000	267749
MN-60-300	10,0	135	10	200	267756
MN-60-310	11,0	145	10	200	267763
MN-60-320	12,0	150	10	200	267770

* 2 pcs in pack



HSS-G GROUND METAL DRILL BIT









index				5906757
	pieces	sets	sets	
MN-60-904	6	1	100	267503



HSS-G GROUND METAL DRILL BIT SET 2-8 MM, 6 PCS





		
mm	mm	mm
2,0	50	
3,0	60	
4,0	75	
5,0	85	
6,0	95	
8,0	115	

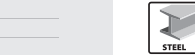

index				5906757
	pieces	sets	sets	
MN-60-906	13	10	100	267480

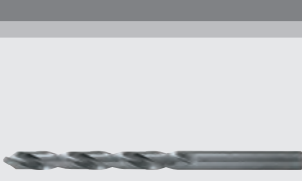

HSS-G GROUND METAL DRILL BIT SET 1,5-6,5 MM, 13 PCS





		
mm	mm	mm
1,5	40	
2,0	50	
2,5	57	
3,0	60	
3,2	65	
3,5	70	
4,0	75	
4,2	75	
4,5	80	
5,0	85	
5,5	95	
6,0	95	
6,5	100	



index				5906757
	pieces	sets	sets	
MN-60-911	10	10	100	267497



HSS-G GROUND METAL DRILL BIT SET 1-10 MM, 10 PCS



		
mm	mm	mm
1,0	35	
2,0	50	
3,0	60	
4,0	75	
5,0	85	
6,0	95	
7,0	110	
8,0	115	
9,0	125	
10,0	135	

index				5906757
	pieces	sets	sets	
MN-60-931	6	10	100	907263



METAL DRILL BIT SET 2-8 MM, 6 PCS



		
mm	mm	mm
2,0	50	
3,0	60	
4,0	75	
5,0	85	
6,0	95	
8,0	115	

METAL DRILL BIT SETU 1,5-6,5 MM, 13 PCS

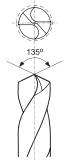

index	pieces	sets	sets	5906757
MN-60-932	13	10	100	907270



	mm	mm
	1,5	40
	2,0	49
	2,5	57
	3,0	61
	3,2	65
	3,5	70
	4,0	75
	4,5	80
	4,8	86
	5,0	86
	5,5	93
	6,0	93
	6,5	101



METAL DRILL BIT SET 2-8 MM, 13 PCS

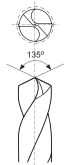

index	pieces	sets	sets	5906757
MN-60-933	13	10	100	907287



	mm	mm
	2,0	49
	2,5	57
	3,0	61
	3,5	70
	4,0	75
	4,5	80
	5,0	86
	5,5	93
	6,0	93
	6,5	101
	7,0	109
	7,5	109
	8,0	117



HSS-R METAL DRILL BIT SET 1-10 MM, 19 PCS

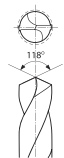



index	pieces	sets	sets	5906757
MN-60-934	19	1	40	907294



	mm	mm
	1,0	34
	1,5	40
	2,0	49
	2,5	57
	3,0	61
	3,5	70
	4,0	75
	4,5	80
	5,0	86
	5,5	93
	6,0	93
	6,5	101
	7,0	109
	7,5	109
	8,0	117
	8,5	117
	9,0	125
	9,5	125
	10,0	133







index				5906675
	mm	pcs	pcs	
MN-61-801	4, 5, 6, 7, 8, 9, 10, 11, 12	1	1	021034
MN-61-802	5, 7, 10, 13, 16, 19, 21, 23, 26, 29, 31, 33, 35	10	90	021041

TiN M2 STEEL

TAPERED DRILL BITS





index					5906757
	mm	mm	pcs	pcs	
MN-61-504	4,0	75	10	200	267831
MN-61-505	5,0	85	10	200	267848
MN-61-506	6,0	93	10	200	267855
MN-61-508	8,0	120	10	200	267879
MN-61-510	10,0	135	10	150	267893
MN-61-512	12,0	150	10	150	267909



BRAD POINT WOOD DRILL BITS









index				5906757
	pieces	sets	sets	
MN-61-571	5	10	120	267169



BRAD POINT WOOD DRILL BIT SET 4-10 MM, 5 PCS





		
	mm	mm
	4,0	75
	5,0	85
	6,0	93
	8,0	120
	10,0	135





index				5906757
	pieces	sets	sets	
MN-61-572	8	10	80	267176



BRAD POINT WOOD DRILL BIT SET 3-10 MM, 8 PCS



		
	mm	mm
	3,0	60
	4,0	75
	5,0	85
	6,0	93
	7,0	110
	8,0	120
	9,0	125
	10,0	135

index					5906757
	mm	mm	pcs	pcs	
MN-61-616	16,0	155	10	100	246171
MN-61-618	18,0	155	10	100	164734
MN-61-620	20,0	155	10	100	153004
MN-61-622	22,0	155	10	100	152984
MN-61-625	25,0	155	10	100	153028
MN-61-628	28,0	155	10	100	153080
MN-61-630	30,0	155	10	100	153035
MN-61-632	32,0	155	10	100	153042
MN-61-635	35,0	155	10	100	153059
MN-61-640	40,0	155	10	100	153066



FLATWOOD DRILL BITS



**FLATWOOD DRILL BIT SET
16-25 MM, 3 PCS**



index	①	📦	📦	5906757
	pieces	sets	sets	
MN-61-753	3	10	40	265189

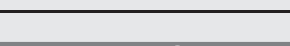

	📏	📏
	mm	mm
	16,0	155
	20,0	155
	25,0	155

**FLATWOOD DRILL BIT SET
12-26 MM, 6 PCS**



index	①	📦	📦	5906757
	pieces	sets	sets	
MN-61-756	6	5	20	265196



	📏	📏
	mm	mm
	12,0	155
	16,0	155
	20,0	155
	22,0	155
	24,0	155
	26,0	155

CONFIRMAT SCREW DRILL BITS





index	📏	📏	📦	📦	5906757
	mm	mm	pcs	pcs	
MN-61-678	5,0	90	1	20	272309
MN-61-680	7,0	90	1	20	089396



SET MILLING CUTTERS WOOD 15-35 MM, 5 PCS

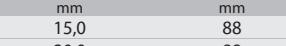
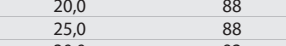
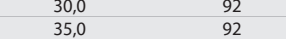
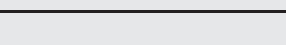

index	①	📦	📦	5906757
	pieces	sets	sets	
MN-61-760	5	5	20	000988





	📏	📏
	mm	mm
	15,0	88
	20,0	88
	25,0	88
	30,0	92
	35,0	92

GLASS DRILL BITS



index	📏	📏	📦	📦	5906757
	mm	mm	pcs	pcs	
MN-61-204	4,0	67	10	200	270770
MN-61-205	5,0	67	10	200	270787
MN-61-206	6,0	72	10	200	270794
MN-61-208	8,0	80	10	200	270800
MN-61-210	10,0	90	10	200	270817
MN-61-212	12,0	100	10	10	901759





index					5906757
	mm	mm	pcs	pcs	
MN-61-054	5,0	85	10	500	163287
MN-61-056	6,0	100	10	500	163294
MN-61-057	6,0	200	10	250	266377
MN-61-064	8,0	120	10	500	163300
MN-61-065	8,0	200	10	250	266384
MN-61-070	10,0	120	10	500	163317
MN-61-071	10,0	200	10	250	266391
MN-61-076	12,0	150	10	2000	163324
MN-61-077	12,0	200	10	1500	266407





GROUND CONCRETE DRILL BITS







index				5906757
	pieces	sets	sets	
MN-61-106	5	10	100	267466



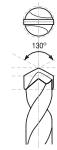

		
	mm	mm
	4,0	75
	5,0	85
	6,0	100
	8,0	120
	10,0	120

GROUND CONCRETE DRILL BIT SET 4-10 MM, 5 PCS









index				5906757
	pieces	sets	sets	
MN-61-109	8	10	100	267473

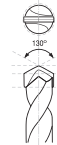

		
	mm	mm
	3,0	65
	4,0	75
	5,0	85
	6,0	100
	7,0	100
	8,0	120
	9,0	120
	10,0	120

GROUND CONCRETE DRILL BIT SET 3-10 MM, 8 PCS







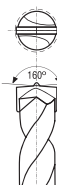

index						5906757
	mm	mm	mm	pcs	pcs	
MN-61-116	5	50	110	100	400	274341
MN-61-117	5	100	160	25	200	274358
MN-61-121	6	50	110	25	200	274020
MN-61-122	6	100	160	25	200	274037
MN-61-123	6	150	210	25	200	274044
MN-61-124	6	200	260	25	200	274051
MN-61-131	8	50	110	25	200	274068
MN-61-132	8	100	160	25	200	274075
MN-61-133	8	150	210	25	200	274082
MN-61-134	8	200	260	25	200	274099
MN-61-137	8	410	460	1	100	274105
MN-61-141	10	50	110	50	200	274112
MN-61-142	10	100	160	25	200	274129
MN-61-143	10	150	210	25	200	274136
MN-61-144	10	200	260	25	200	274143
MN-61-145	10	250	300	25	200	274150
MN-61-147	10	410	460	10	100	274167
MN-61-148	10	550	600	25	50	274174
MN-61-152	12	100	160	25	200	274181
MN-61-153	12	150	210	10	150	274198

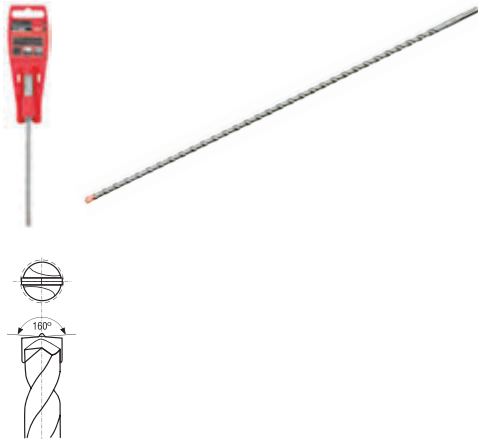
SDS-PLUS DRILL BITS



SDS-PLUS DRILL BITS



index						5906757
	mm	mm	mm	pcs	pcs	
MN-61-154	12	200	260	25	200	274204
MN-61-155	12	250	300	25	100	274211
MN-61-157	12	410	460	25	100	274228
MN-61-158	12	550	600	25	50	274235
MN-61-163	14	150	210	10	150	274242
MN-61-165	14	250	300	20	100	274259
MN-61-167	14	410	460	10	50	274266
MN-61-168	14	550	600	10	50	274273
MN-61-175	16	250	300	20	100	274280
MN-61-177	16	410	460	10	50	274297
MN-61-178	16	550	600	10	50	274303
MN-61-187	18	410	460	10	50	274310
MN-61-197	20	410	460	10	30	274327







SDS-PLUS DRILL BITS 6-12 MM, 4 PCS







index				5906757
	pieces	sets	sets	
MN-61-202	4	10	100	902176



			
	mm	mm	mm
	6,0	100,0	160,0
	8,0	100,0	160,0
	10,0	100,0	160,0
	12,0	100,0	160,0

SDS-PLUS FLAT CHISELS







index					5906757
	mm	mm	pcs	pcs	
MN-61-091	20	250	50	100	907393
MN-61-092	40	250	50	100	907409



SDS-PLUS POINTED CHISEL





index					5906757
	mm	mm	pcs	pcs	
MN-61-093	—	250	50	100	907416



SDS-PLUS GOUGE CHISEL



index					5906757
	mm	mm	pcs	pcs	
MN-61-094	20	250	50	100	907423



index				pcs	pcs	5906675
	mm	mm	mm			
MN-61-902	5	50	110	25	200	412955
MN-61-903	5	100	160	25	200	412962
MN-61-904	6	50	110	25	200	412979
MN-61-905	6	100	160	25	200	412986
MN-61-906	6	150	210	25	200	412993
MN-61-907	6	200	260	25	200	413006
MN-61-908	8	50	110	25	200	413013
MN-61-909	8	100	160	25	200	413037
MN-61-910	8	150	210	25	200	413044
MN-61-911	8	200	260	25	200	413051
MN-61-937	8	250	310	25	200	001442
MN-61-938	8	300	360	25	200	001459
MN-61-912	8	410	460	25	100	413068
MN-61-913	10	50	110	25	200	413075
MN-61-914	10	100	160	25	200	413082
MN-61-915	10	150	210	25	200	413099
MN-61-916	10	200	260	25	200	413105
MN-61-917	10	250	300	25	200	413112
MN-61-918	10	410	460	25	100	413136
MN-61-919	10	550	600	25	50	413143
MN-61-920	12	100	160	25	200	413150
MN-61-921	12	150	210	25	200	413167
MN-61-922	12	200	260	25	200	413174
MN-61-923	12	250	300	25	100	413181
MN-61-924	12	400	450	25	100	413198
MN-61-925	12	550	600	25	50	413204
MN-61-926	14	150	210	20	200	413211
MN-61-927	14	250	300	20	100	413235
MN-61-928	14	400	450	10	50	413242
MN-61-929	14	550	600	10	50	413259
MN-61-930	16	250	300	20	100	413266
MN-61-931	16	400	450	10	50	413273
MN-61-932	16	550	600	10	50	413280
MN-61-933	18	400	450	10	50	413297
MN-61-934	20	410	460	10	40	413303



SDS-PLUS DRILL BITS



POWER TOOL ACCESSORIES

index				pcs	pcs	5906675
	mm	mm	mm			
MN-61-950	16	200	340	10	40	413310
MN-61-951	16	400	540	10	20	413334
MN-61-952	18	200	340	10	40	413341
MN-61-953	18	400	540	10	20	413358
MN-61-954	20	200	340	10	40	413365
MN-61-955	20	400	540	10	20	413372
MN-61-956	22	200	340	10	40	413389
MN-61-957	22	400	540	10	20	413396
MN-61-958	24	200	340	10	40	413402
MN-61-959	24	400	540	10	20	413419
MN-61-960	25	200	340	10	40	413433
MN-61-961	25	400	540	10	20	413440
MN-61-962	26	200	340	5	20	413457
MN-61-963	26	400	540	5	15	413464
MN-61-964	28	200	340	5	20	413471
MN-61-965	28	400	540	5	15	413488
MN-61-966	30	200	340	5	20	413495
MN-61-967	30	400	540	5	15	413501
MN-61-968	32	200	340	5	20	413518
MN-61-969	32	400	540	5	15	413525



SDS-MAX DRILL BITS



DIAMOND HOLE SAW - M14



index					5906675
	mm	mm	pcs	pcs	
MN-76-206	6	65	10	100	455266
MN-76-208	8	65	10	100	455273
MN-76-210	10	65	10	100	455280
MN-76-212	12	65	10	100	455297
MN-76-225	25	60	10	100	455303
MN-76-235	35	60	5	50	455310
MN-76-245	45	60	5	50	474762
MN-76-255	55	60	5	50	474779
MN-76-268	68	60	5	50	474786

M14 shank



DIAMOND HOLE SAW - HEX



index					5906675
	mm	mm	pcs	pcs	
MN-76-306	6	70	20	200	455228
MN-76-308	8	80	20	200	455235
MN-76-310	10	80	20	200	455242
MN-76-312	12	80	20	200	455259

HEX shank



DIAMOND HOLE SAWS SET - M14



index					5906675
	mm	mm	pcs	pcs	
MN-76-290	6, 8, 10, 12	65	10	60	7001404

M14 shank
M14/HEX adapter



DIAMOND HOLE SAWS SET - HEX



index					5906675
	mm	mm	pcs	pcs	
MN-76-294	5, 6, 8, 10, 12	70-80	10	60	7001398

HEX shank



DIAMOND HOLE SAW GUIDE



index			5906675
	pcs	pcs	
MN-76-298	5	50	455327



DIAMOND CROWNS



index					5906675
	mm	mm	pcs	pcs	
MN-61-240	62	80	5	20	014616
MN-61-241	82	80	5	20	014630

SDS-Plus shank
4 diamond segments





PILOT DRILL BIT



index					5906675
	mm	mm	pcs	pcs	
MN-61-246	10,0	120	1	30	014654



for diamond crowns
taper shank key for
removal





index					5906757
	mm	mm	pcs	pcs	
	HEX				
MN-61-266	65	155	10	30	144842
MN-61-281	80	155	10	20	144859
	SDS plus				
MN-61-366	65	155	10	30	151659
MN-61-381	80	155	10	20	151666





amount of sintered carbides
 ø65 mm-8 pcs
 ø80 mm-10 pcs





index				5906757
	pieces	sets	sets	
MN-76-104	6	1	20	151604







	
mm	mm
33,0	65,0
53,0	65,0
67,0	65,0
83,0	65,0

index				5906675
	mm	pcs	pcs	
MN-76-120	33,0; 43,0; 53,0; 67,0; 73,0; 83,0	10	50	014593



index					5906675
	mm	mm	pcs	pcs	
MN-76-122	8,0	135	1	30	014609



index					5906675
	mm	mm	pcs	pcs	
MN-76-123	33,0	65	10	30	014548
MN-76-124	43,0	65	10	30	014661
MN-76-125	53,0	65	1	30	014555
MN-76-126	67,0	65	10	30	014562
MN-76-127	73,0	65	10	50	014579
MN-76-128	83,0	65	10	50	014586



CORE DRILL BITS

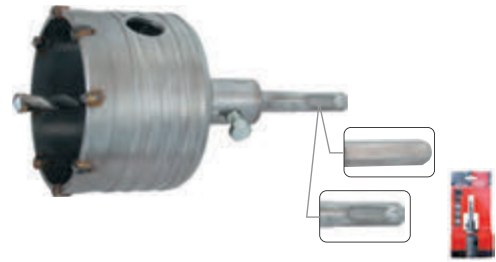

HOLE SAW SET 33-83 MM, 6 PCS



FIXING RING FOR HOLE SAWH 33-83 MM



PILOT DRILL BIT



HOLE SAW



CORE DRILL BIT



index					5906675
	mm	mm	pcs	pcs	
MN-61-406	22,0	52,0	10	360	900295
MN-61-408	25,0	52,0	1	360	900295
MN-61-411	30,0	52,0	10	180	900318
MN-61-413	35,0	52,0	1	180	900332
MN-61-417	44,0	47,0	1	120	900462
MN-61-420	51,0	47,0	10	120	900370
MN-61-423	64,0	47,0	1	120	900394
MN-61-427	73,0	47,0	10	60	900400
MN-61-434	102,0	47,0	1	60	900431



PILOT DRILL BIT



index				5906757
	mm	pcs	pcs	
MN-61-452	14-30	10	120	900479
MN-61-454	32-168	10	60	900486



HOLE SAW SET 51-102 MM, 9 PCS



index				5906757
	pieces	sets	sets	
MN-65-621	9	1	20	248151



mm	mm
51	25
57	25
67	25
76	25
88	25
102	25

HOLE SAW SET 19-64 MM



index				5906757
	pieces	sets	sets	
MN-65-622	11	1	30	248168







mm	mm
19	25
22	25
29	25
35	25
38	25
44	25
51	25
64	25

SDS-PLUS ADAPTER - 1/2"







index			5906757
	pcs	pcs	
MN-61-395	1	120	163607

index					5906757
	mm	inch	pcs	pcs	
MN-97-043	1,5-13,0	1/2	6	30	268593

body made of ABS plastic
bottom part made of steel
additional blocking function
CLICK

KEYLESS DRILL CHUCKS CLICK 1,5-13 MM







indeks					5906675
	mm	mm	blister	blister	
MN-65-164	152	8,0	1	200	393100
MN-65-165	228	8,0	1	100	393117
MN-65-166	152	4,0	1	200	393124
MN-65-167	240	5,0	1	200	393131

packed
in 3 pieces in a blister

RECIPROCATING SAW BLADES









indeks					5906675
	mm	mm	blister	blister	
MN-65-168	152	1,8	1	200	393148
MN-65-169	150	1,0	1	200	393155
MN-65-170	228	1,8	1	200	393162

pakowane po 3 szt. w blisterze packed in 3 pieces in a blister упаковано в 3 штуки в блистере

RECIPROCATING SAW BLADES



indeks							5906757
	mm	mm	mm	description	blister	blister	
MN-65-182	76	51	1,2	C	1	100	907874
MN-65-183	76	51	2,0	C	1	100	907881
MN-65-184	76	51	1,2	B	1	100	907898
MN-65-185	100	75	3,0	F	1	100	907904

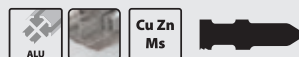

T-SHANK JIG SAW BLADES



T-SHANK JIG SAW BLADES



indeks							5906757
	mm	mm	mm	description	blister	blister	
MN-65-186	116	90	3,0	A	100	600	907911
MN-65-187	76	51	1,4	B	1	100	907928
MN-65-188	100	75	2,5	C	1	100	907935
MN-65-189	100	75	2,5	D	1	100	907942
MN-65-190	76	51	2,0	C	1	100	907959
MN-65-191	100	75	2,0	C	1	100	907966
MN-65-192	100	75	3,0	E	1	100	907973
MN-65-193	100	75	4,0	E	1	100	907980
MN-65-196	100	51	2,5	D	1	100	908017



T-SHANK JIG SAW BLADES



indeks							5906757
	mm	mm	mm	description	blister	blister	
MN-65-194	76	51	1,2	C	1	100	907997
MN-65-195	76	51	3,0	E	1	100	908000

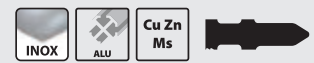

U-SHANK JIG SAW BLADES



indeks							5906757
	mm	mm	mm	description	blister	blister	
MN-65-197	100	75	3,0	F	1	100	908024

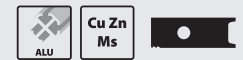

U-SHANK JIG SAW BLADES



indeks							5906757
	mm	mm	mm	description	blister	blister	
MN-65-198	100	75	3,0	C	100	400	908031



U-SHANK JIG SAW BLADES



indeks							5906757
	mm	mm	mm	description	blister	blister	
MN-65-199	100	75	2,5	A	1	100	908048
MN-65-200	100	75	2,5	D	1	100	908055
MN-65-201	100	75	3,0	C	1	100	908062



Legend for Jigsaw blades

- A** coarse cut
- B** curved cutting
- C** straight cut
- D** inverted tooth, for cutting MDF
- E** fast straight cutting
- F** fast curved cutting

index		grain size				5906675
	mm		pcs	pcs	pcs	
MN-68-801	225	60	5	1	100	077260
MN-68-803	225	100	5	1	100	077277
MN-68-804	225	120	5	1	100	077284
MN-68-806	225	180	5	1	100	077291



SANDING DISCS



index	type		grain size				5906
		mm		pcs	pcs	pcs	
MN-68-540/5	HARD	225	40	5	120	600	675392981
MN-68-541/5	HARD	225	60	5	120	600	675392998
MN-68-542/5	HARD	225	80	5	150	750	675393001
MN-68-543/5	HARD	225	100	5	150	750	675393018
MN-68-544/5	HARD	225	120	5	150	750	675393025
MN-68-545/5	HARD	225	150	5	160	800	675393032
MN-68-546/5	HARD	225	180	5	170	850	675393049
MN-68-547/5	HARD	225	220	5	170	850	675393056



SANDING MESH DISCS

SANDING MESH DISCS
СЕТКА ШЛИФОВАЛЬНАЯ С ВЕЛЮРОМ



index	type		grain size				5906
		mm		pcs	pcs	pcs	
MN-68-548/5	SOFT	225	40	5	110	550	675393063
MN-68-549/5	SOFT	225	60	5	110	550	675393070
MN-68-550/5	SOFT	225	80	5	130	650	675393087
MN-68-551/5	SOFT	225	100	5	130	650	675393094
MN-68-552/5	SOFT	225	120	5	130	650	757275225
MN-68-553/5	SOFT	225	150	5	150	750	675394930
MN-68-554/5	SOFT	225	180	5	150	750	757275232
MN-68-555/5	SOFT	225	220	5	170	850	675394947



SANDING MESH DISCS



SANDING DISCS



index		grain size			5906757
	mm		pcs	pcs	
MN-68-470	125	24	50	1000	142817
MN-68-473	125	36	50	1000	086777
MN-68-476	125	40	50	1000	079519
MN-68-479	125	60	50	1000	080485
MN-68-482	125	80	50	1000	079502
MN-68-485	125	100	50	1000	079526
MN-68-488	125	120	50	1000	080492
MN-68-491	125	150	50	1000	079533
*packing 5 pcs.					
MN-68-470/5	125	24	1	200	265592
MN-68-473/5	125	36	1	200	265608
MN-68-476/5	125	40	1	200	265615
MN-68-479/5	125	60	1	200	265622
MN-68-482/5	125	80	1	200	265639
MN-68-488/5	125	120	1	200	265660



ENDLESS ABRASIVE PAPERS



index	grain size			5906757
		pcs	pcs	
MN-68-461/5	40	6	30	901117
MN-68-462/5	60	6	30	275041
MN-68-463/5	80	6	30	275058
MN-68-464/5	100	6	30	275065
MN-68-465/5	120	6	30	275072

dimensions 75x533mm
5 pcs

index	grain size			5906757
		pcs	pcs	
MN-68-460/5	40	6	30	335650
MN-68-466/5	60	6	30	335667
MN-68-467/5	80	6	30	335674
MN-68-468/5	100	6	30	335698
MN-68-469/5	120	6	30	335704

dimensions 75x533mm
5 pcs



POLISHING FELT DISCS



index				5906757
	mm	pcs	pcs	
MN-68-620	125	1	20	082489





POLISHING WOOL DISCS



index				5906757
	mm	pcs	pcs	
MN-68-622	125	1	20	082496



index				5906757
	mm	pcs	pcs	
MN-68-624	125	1	24	903722







POLISHING LAMB WOOL BONNETS



index					5906757
	mm		pcs	pcs	
MN-68-611	125	M14	1	20	267329





FLEXIBLE BACKING PADS



index					5906757
	mm	mm	pcs	pcs	
MN-68-605	125	8,0	20	80	082502





BACKING PADS



index					5906757
	mm	mm	pcs	pcs	
MN-68-606	125	8,0	1	20	905528

BACKING PADS WITH JOINT



index						5906757
	mm		mm	pcs	pcs	
MN-68-609	125	M14	8,0	20	100	267336

BACKING PADS OF LINING



BACKING PADS

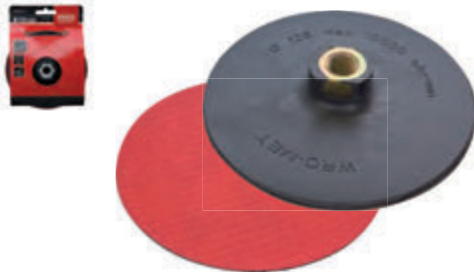

index					5906757
	mm		pcs	pcs	
MN-68-608	125	M14	25	100	267312

DEPRESSED DISCS



index						5906757
	mm	mm	mm	pcs	pcs	
MN-68-902	125	22,23	3,0	25	200	162822
MN-68-905	230	22,23	3,0	25	50	162907



FLAT DISCS



index						5906757
	mm	mm	mm	pcs	pcs	
MN-68-907	300	32	3,0	5	25	162976
MN-68-908	350	32	3,0	5	25	162983
MN-68-909	400	32	3,0	5	25	162990



FLAT DISCS



index						5906757
	mm	mm	mm	pcs	pcs	
MN-68-961	115	22,23	1,0	25	500	904859
MN-68-962	125	22,23	1,0	25	500	904866
MN-68-966	115	22,23	1,6	25	500	904897
MN-68-967	125	22,23	1,6	25	500	904903
MN-68-965	230	22,23	1,9	25	50	904873







FLAT DISCS



index						5906757
	mm	mm	mm	pcs	pcs	
MN-68-911	115	22,23	1,0	25	500	162914
MN-68-912	125	22,23	1,0	25	500	162921
MN-68-915	230	22,23	1,9	25	100	270428
MN-68-916	115	22,23	1,6	25	500	904798
MN-68-917	125	22,23	1,6	25	500	904804







index						5906757
	mm	mm	mm	pcs	pcs	
MN-68-931	115	22,23	1,6	25	500	273597
MN-68-932	125	22,23	1,6	25	500	273603
MN-68-935	230	22,23	1,9	25	50	273627



ALUMINIUM CUTTING DISC







index						5906757
	mm	mm	mm	pcs	pcs	
MN-68-922	125	22,23	6,0	25	100	162945
MN-68-925	230	22,23	6,0	10	30	162969



METAL GRINDING DISC







index						5906757
	mm	mm	mm	pcs	pcs	
MN-68-942	125	22,23	3,0	25	200	162860
MN-68-945	230	22,23	3,0	25	50	162884



CONCRETE CUTTING DISC







index			grain size			5906757
	mm	mm		pcs	pcs	
MN-68-811	115	22,23	40	10	200	270244
MN-68-812	115	22,23	60	10	200	270251
MN-68-813	115	22,23	80	10	200	270268
MN-68-814	115	22,23	100	10	200	270275
MN-68-815	115	22,23	120	10	200	270282
MN-68-821	125	22,23	40	10	200	270299
MN-68-822	125	22,23	60	10	200	270305
MN-68-823	125	22,23	80	10	200	270312
MN-68-824	125	22,23	100	10	200	270329
MN-68-825	125	22,23	120	10	200	270336

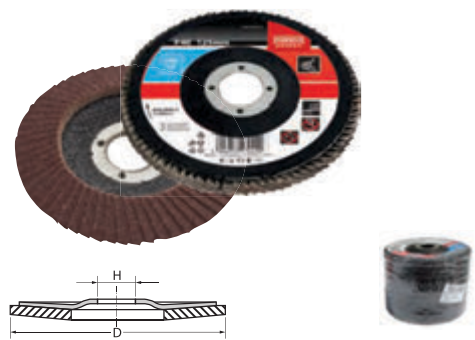

FLAP SANDING DISCS 115/125MM



index			grain size			5906675
	mm	mm		pcs	pcs	
MN-68-831	115	22,23	40	10	200	420899
MN-68-832	115	22,23	60	10	200	420905
MN-68-833	115	22,23	80	10	200	420912
MN-68-834	115	22,23	100	10	200	420936
MN-68-835	115	22,23	120	10	200	420943
MN-68-841	125	22,23	40	10	200	420950
MN-68-842	125	22,23	60	10	200	420967
MN-68-843	125	22,23	80	10	200	420974
MN-68-844	125	22,23	100	10	200	420981
MN-68-845	125	22,23	120	10	200	420998



FLAP SANDING DISCS 115/125MM



DIAMOND BLADES

DIAMOND BLADES
ДИСКИ АЛМАЗНЫЕ



index					5906757
	mm	mm	pcs	pcs	
MN-78-132	115	22,23	10	100	267237
MN-78-133	125	22,23	10	100	267244
MN-78-135	230	22,23	10	20	267268



DIAMOND BLADES TURBO



index					5906757
	mm	mm	pcs	pcs	
MN-78-312	115	22,23	10	100	273788
MN-78-313	125	22,23	10	100	273795
MN-78-315	230	22,23	10	20	273818



DIAMOND BLADES



index					5906757
	mm	mm	pcs	pcs	
MN-78-212	115	22,23	10	100	273740
MN-78-213	125	22,23	10	100	273757
MN-78-215	230	22,23	10	20	273771



DIAMOND BLADES



index					5906757
	mm	mm	pcs	pcs	
MN-78-220	200	25,4/22,23	10	50	274440

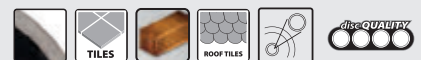





DIAMOND BLADES FOR GRINDING UNIVERSAL



index					5906675
	mm	mm	pcs	pcs	
MN-78-411	125	22,23	10	40	022109





index					5906675
	mm	mm	pcs	pcs	
MN-78-412	125	22,23	10	40	022116



DIAMOND BLADES FOR GRINDING HEAVY DUTY







index					5906675
	mm	mm	pcs	pcs	
MN-78-413	125	22,23	10	40	022130



DIAMOND BLADES FOR GRINDING FAST



index						5906757
	mm	mm	kg	pcs	pcs	
MN-79-061	80	400	5-15	1	10	146037
MN-79-063	100	500	15-25	1	10	146129





for emulsion, acryl, dispersion paints and stains





Hex Shank

STIRRING PADDLES TYPE A







index						5906757
	mm	mm	kg	pcs	pcs	
MN-79-069	80	400	1-10	1	10	146266
MN-79-071	100	500	10-20	1	10	146297
MN-79-073	120	600	16-35	1	10	146310

M14 Shank

index						5906757
	mm	mm	kg	pcs	pcs	
MN-79-081	100	600	10-20	1	10	902183
MN-79-082	120	600	16-35	1	10	272590
MN-79-083	135	600	20-40	1	6	902213

SDS+ Shank

index						5906757
	mm	mm	kg	pcs	pcs	
MN-79-074	100	600	10-20	1	10	033907
MN-79-080	120	600	16-35	1	10	151383



for adhesives, tiles and thermal insulation structural plasters and mortars

Hex Shank

STIRRING PADDLES TYPE C



SET 2 TYPES C TYP TO THE MIXER



index					5906757
	mm	mm	pcs	pcs	
MN-79-089	100	540	1	4	000698



STIRRING PADDLES TYPE D DYNAMIC



index						5906757
	mm	mm	kg	pcs	pcs	
MN-79-078	80	400	10-20	1	10	155060
MN-79-079	100	500	15-30	1	10	155077



for adhesives for
tiles and thermal
insulation structural
plasters and mortars

STIRRING PADDLES TYPE E



index						5906757
	mm	mm	kg	pcs	pcs	
MN-79-075	80	400	10-15	1	8	146327
MN-79-077	100	500	12-30	1	8	146334

SDS+ Shank

	mm	mm	kg	pcs	pcs	
MN-79-076	100	500	16-25	1	8	089089

M14 Shank

	mm	mm	kg	pcs	pcs	
MN-79-093	120	600	16-35	1	10	902237

for plasters
putty plasters
gypsum plasters



Hex Shank

STIRRING PADDLES TYPE F



index						5906757
	mm	mm	kg	pcs	pcs	
MN-79-095	120	600	10-30	1	10	909731
MN-79-096	140	600	10-40	1	6	909748



for adhesives for tiles
and thermal insulation
structural plasters and
mortars





M14 shank

WIRE WHEELS



index					5906757
	mm	mm	pcs	pcs	
MN-69-142	115	22,23	12	48	269088
MN-69-144	150	22,23	12	48	269095







index					5906757
	mm	inch	pcs	pcs	
MN-69-172	65	1/4	12	96	269101
MN-69-173	75	1/4	12	96	269118
MN-69-175	100	1/4	12	96	269125



WIRE WHEELS







index					5906757
	mm	inch	pcs	pcs	
MN-69-191	50	1/4	12	96	269132
MN-69-193	75	1/4	12	96	269149



WIRE CUP BRUSHES







index					5906757
	mm	mm	pcs	pcs	
MN-69-164	80	M14	12	72	269064
MN-69-165	100	M14	12	48	269071



WIRE CUP BRUSHES







index					5906757
	mm	mm	pcs	pcs	
MN-69-112	115	M14	12	48	269002
MN-69-114	150	M14	12	24	269019



WIRE WHEELS



index					5906757
	mm	mm	pcs	pcs	
MN-69-121	100	M14	12	72	269040
MN-69-122	150	M14	12	48	269057



WIRE WHEELS



WIRE CUP BRUSHES



index					5906757
	mm	mm	pcs	pcs	
MN-69-134	80	M14	12	48	269026
MN-69-135	100	M14	12	48	269033



WELDING RODS 5KG



index				5906675
	mm	kg	kg	
MN-97-904	2,5	5	5	980270
MN-97-906	3,2	5	5	980577
MN-97-909	4,0	5	5	013732



SOLDERS 5KG



index				5906675
	sztuki/pieces/части	kg	kg	
MN-97-960	15,5	5	5	962573



GLUE STICKS FOR GLUE GUNS GEN-T



index				5906757
	kg	pcs	pcs	
MN-97-980-1	1,00	1	1	906426
MN-97-980-5	5,00	1	1	906471
MN-97-980-B	0,10	1	10	906518



resistance to temp. -5°C setting time 35-40 sec.

transparent

GLUE STICKS FOR GLUE GUNS PRO+



index				5906757
	kg	pcs	pcs	
MN-97-993-1	1,00	1	1	906747
MN-97-993-5	5,00	1	1	906495
MN-97-993-B	0,10	1	10	906532



resistance to temp. -15°C setting time 30-35 sec.

superstrong

honey

index	kg	pcs	pcs	5906757
MN-97-994-1	1,00	1	1	906433
MN-97-994-5	5,00	1	1	906488
MN-97-994-B	0,10	1	10	906525



resistance to temp. -5°C setting time 35-40 sec.

transparent

PVC, cables, plastics

GLUE STICKS FOR GLUE GUNS PRO-T



index	kg	pcs	pcs	5906757
MN-97-995-1	1,00	1	5	906440
MN-97-995-5	5,00	1	1	906501
MN-97-995-B	0,10	1	10	906549



resistance to temp. 0°C setting time 25-30 sec.

white

GLUE STICKS FOR GLUE GUNS PRO-B



index	kg	pcs	pcs	5906757
MN-97-996-1	1,00	1	1	906457
MN-97-996-5	5,00	1	1	906761
MN-97-996-B	0,10	1	10	906556



resistance to temp. -5°C setting time 30-35 sec.

miodowy honey жёлтый

KLEJE DO PISTOLETÓW W SZTYFTACH ASS

GLUE STICKS FOR GLUE GUNS ASS
КЛЕЕВЫЕ ПАТРОНЫ ASS



index	kg	pcs	pcs	5906757
MN-97-997-1	1,00	1	1	906464
MN-97-997-5	5,00	1	1	906778
MN-97-997-B	0,10	1	10	906563



resistance to temp. 0°C setting time 8-12 sec.

mleczny milk молочный

GLUE STICKS FOR GLUE GUNS PAC



index	dedicated to	capacity	pcs	590
MN-94-190	DEWALT, KÄRCHER	12,5	1	5 6675329208
MN-94-191	NILFISK Buddy II	10,5	1	5 1362007308
MN-94-192	NILFISK Multi	13,5	1	5 1362007315
MN-94-193	DELONGHI, DEXTER, EINHELL, MODECO (MN-94-151)	7,4	1	5 6675192888
MN-94-194	EINHELL, GRAPHITE, PARKSIDE	9,6	1	5 6675192895
MN-94-196	MODECO EXPERT, KÄRCHER	10,5	1	5 6675193243
MN-94-197	KÄRCHER SER. A	3,8	1	5 6675193250
MN-94-198	KÄRCHER, ELECTROLUX, TORNADO	12,5	1	5 6675193281
MN-94-199	KÄRCHER WD 3, AQUA VAC, EINHELL, ROWENTA	25,6	1	12 6675193304
MN-94-200	METABO, BOSCH, KRESS	15,0	1	5 6675193311
MN-94-201	MACALLISTER, MODECO (MN-94-152)	19,3	1	12 6675193335
MN-94-202	MAKITA 440, 445, 448	19,7	1	12 6675201320
MN-94-203	GRAPHITE, MICHELIN	15,0	1	5 1362007483

BAGS FOR VACUUM CLEANERS

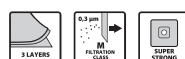

Basic tools are indispensable in every household and workshop. With their help, any DIYer can easily handle the repair of many defects.

BASIC TOOLS

Basic tools are easy to use, making it possible to work quickly and efficiently, let alone effectively and, most importantly, safely. The range of the Modeco Expert basic tools comprises high-quality tools made of good-quality materials and alloy steels. There is something for everyone – from professionals, who provide their services on a large scale, to DIYers. Their main targets include fitters, mechanics, electricians, plasterers, DIYers, roofers, road builders, tile setters, plumbers, joiners, and steel fixers. It is for them that we have designed and developed the Modeco Expert selection of basic tools including screwdrivers, voltage testers, pliers, cutters, pipe spanners, hammers, vices, and clamps.



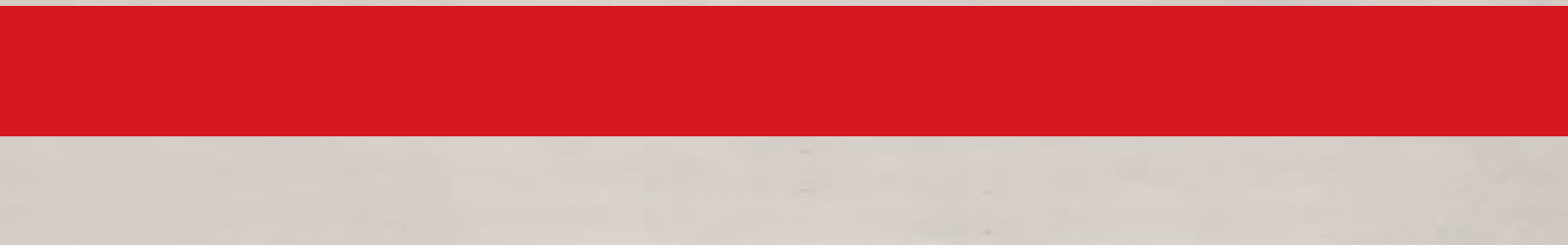

FLAT SCREWDRIVERS SUPREME



index					5906757
	mm	mm	pcs	pcs	
MN-10-151	3,0	75	6	120	902695
MN-10-152	4,0	75	6	120	902701
MN-10-153	5,0	100	6	90	902718
MN-10-154	5,0	150	6	120	902725
MN-10-157	6,0	100	6	90	902749
MN-10-159	6,0	150	6	90	902756
MN-10-160	8,0	150	6	60	902763



PHILIPS SCREWDRIVERS SUPREME



index					5906757
	mm	mm	pcs	pcs	
MN-10-161	PH0	60	6	120	902770
MN-10-162	PH1	80	6	120	902787
MN-10-163	PH2	38	6	120	902794
MN-10-165	PH2	100	6	90	902800
MN-10-168	PH3	150	6	60	902817



POZIDRIVE SCREWDRIVERS SUPREME



index					5906757
	mm	mm	pcs	pcs	
MN-10-171	PZ0	60	6	120	902824
MN-10-172	PZ1	80	6	120	902831
MN-10-173	PZ2	38	6	120	902848
MN-10-175	PZ2	100	6	90	902855



SCREWDRIVER SET SL, PH SUPREME 4 PCS



index				5906757
	pieces	pcs	pcs	
MN-11-081	4	6	24	903074



	mm	mm		
		5,0	100	
		6,0	150	
		PH1	75	
		PH2	100	





SCREWDRIVER SET SL, PH SUPREME 6 PCS



index				5906757
	pieces	pcs	pcs	
MN-11-082	6	6	24	903081



	mm	mm		
		3,0	75	
		5,0	75	
		5,0	150	
		PH0	75	
		PH1	100	
		PH2	100	





index						5906757
	mm	mm	mm	pcs	pcs	
MN-13-004	6,0	1,2	100	12	96	119840
MN-13-007	8,0	1,2	150	12	96	267930
MN-13-009	9,0	1,5	200	12	96	271357



FLAT SCREWDRIVERS WITH STRIKING CAPS IMPACT





BASIC TOOLS

index					5906757
	mm	mm	pcs	pcs	
MN-13-014	PH2	100	12	96	267947
MN-13-017	PH3	150	12	96	267954











FLAT SCREWDRIVERS PH2/PH3





index				5906757
	pieces	pcs	pcs	
MN-10-107	13	6	24	013800



















			mm	mm
			3,0; 4,0; 5,0; 6,0; 7,0	25
			PH0; PH1; PH2; PH3	25
			PZ1; PZ2; PZ3	25

SCREWDRIVER WITH INTERCHANGEABLE BITS SUPREME



index				5906675
	pieces	pcs	pcs	
MN-10-200	29	6	24	489872



			mm	mm
			3; 4; 5; 6; 7	25
			PH1; PH2; PH3	25
			PZ1; PZ2	25
			T15; T20; T25	25
			1; 2; 3	25
			5; 6; 7; 8; 9; 10; 11	25
			3; 4; 5	25

"T" SCREWDRIVER WITH INTERCHANGEABLE BITS AND SOCKETS



SCREWDRIVER SET 39 PCS



index	pieces	pcs	pcs	5906757
MN-14-205	39	6	24	088693

CR-V

		mm	mm
	⌀	3,0; 4,0; 5,0; 6,0	25
	+	PH0; PH1; PH2; PH3	25
	+	PZ0; PZ1; PZ2; PZ3	25
	⌘	T10; T15; T20; T25; T27; T30	25
	●	4, 5, 6	25
	○	4,0; 4,5; 5,0; 5,5; 6,0; 6,5; 7,0; 8,0; 9,0; 10,0; 11,0; 13,0	25

SCREWDRIVER SET 45 PCS



index	pieces	pcs	pcs	5906757
MN-14-206	45	6	24	088709

CR-V

		mm	mm
	⌀	3,0; 4,0; 5,0; 6,0	25
	+	PH0x2; PH1x2; PH2x2; PH3	25
	+	PZ0x2; PZ1x2; PZ2x2; PZ3	25
	⌘	T10; T15; T20; T25; T27; T30; T40	25
	●	4, 5, 6	25
	○	4,0; 4,5; 5,0; 5,5; 6,0; 6,5; 7,0; 8,0; 9,0; 10,0; 11,0; 13,0	25

	inch
	1/2"

SCREWDRIVER SET 67 PCS



index	pieces	pcs	pcs	5906757
MN-14-207	67	6	24	088716

CR-V

		mm	mm
	⌀	3,0 x2; 4,0 x2; 5,0 x2; 6,0 x2; 7,0 x2	25
	+	PH0 x2; PH1 x2; PH2 x2; PH3 x2	25
	+	PZ0 x2; PZ1 x2; PZ2 x2; PZ3 x2	25
	⌘	T10 x2; T15 x2; T20 x2; T25 x2; T27 x2; T30 x2; T40 x2	25
	⌘	T10 x2; T15 x2; T20 x2; T25 x2; T27 x2; T30 x2	25
	●	1, 2, 3	25

TOOLS FOR ELECTRICIANS

The work performed by electricians involves occupational hazards associated with the maintenance of indoor and outdoor electrical equipment and systems as well as with building construction.

What we can do to increase the safety and comfort of their work is to provide suitable products catering to the needs of this professional group. The Modeco Expert electrician's tools are characterised by high durability, human engineering properties that improve work quality and comfort, and multi-functionality, which translates into fewer individual tools in an electrician's toolbox.

The Modeco Expert electrician's tools featuring 1000V insulation ensure efficient and safe work. In this product group, both professional electricians and DIYers will find products that meet their specific needs. Additionally, the Modeco Expert group has created a series of tools that allow you to perform additional wire working activities. These include a specialised high-precision telephone and network terminal crimping tool, an automatic wire stripper dedicated to cables of various diameters, and a cable crimping tool featuring a high-precision automatic press.

▶ **3 tools in one** - cutting, crimping terminals and stripping with processing the cable to a specific length

▶ **Jaws for crimping** cable lugs in the range of 10-22 AWG (0.5-6 mm²) and a diameter of 7-8 mm





◀ **Automatic adjustment** to the cable diameter protects it from damage and increases work efficiency

◀ **The wire cutter** located in the handle guarantees the cutting of Cu and Al conductors with a maximum cross-section of 6 mm²



VDE INSULATED SCREWDRIVERS - SL







index						5906757
	mm	mm	mm	pcs	pcs	
MN-10-551	3,5	0,6	75	12	240	268715
MN-10-552	4,0	0,8	100	12	240	268722
MN-10-553	5,5	1,0	125	12	144	268739
MN-10-554	6,5	1,2	150	12	144	268753



VDE INSULATED SCREWDRIVERS - PH



index					5906757
	mm	mm	pcs	pcs	
MN-10-561	PH0	75	12	240	268760
MN-10-562	PH1	100	12	240	268777
MN-10-563	PH2	100	12	144	268784

















VDE INSULATED SCREWDRIVER SET SL, PH 6 PCS







index			5906757
	pieces	pcs	
MN-11-070	6	12	136298



			
	mm	mm	mm
		3,5	75
		4,0	100
		5,5	125
		PH1	100
		PH2	100
		3,5	100

VDE INSULATED SCREWDRIVERS - SL







index						5906675
	mm	mm	mm	pcs	pcs	
MN-10-570	2,5	0,6	75	12	144	489698
MN-10-571	4,0	0,8	100	12	144	489704
MN-10-572	5,5	1,0	125	12	144	489711
MN-10-573	6,5	1,2	150	12	144	489728



VDE INSULATED SCREWDRIVERS - PH



index					5906675
	mm	mm	pcs	pcs	
MN-10-580	PH0	75	12	144	489735
MN-10-581	PH1	80	12	144	489742
MN-10-582	PH2	100	12	144	489759







index					5906757
	mm	mm	pcs	pcs	
MN-17-050	3,0	140	50	100	128576



VEHICLE CIRCUIT TESTER 6-24V







index					5906675
	mm	mm	pcs	pcs	
MN-17-140	3,5	140	20	500	026824



VOLTAGE DETECTOR 100-500V





index					5906675
	mm	mm	pcs	pcs	
MN-17-190	3,5	190	10	400	026831



VOLTAGE DETECTOR 100-250V







index				5906757
	V/B	pcs	pcs	
MN-17-200	70-250	12	240	121133



AUTOMATIC VOLTAGE TESTER 5 IN 1 70-250 V



index					5906757
	mm	mm	pcs	pcs	
MN-17-240	3,0	140	30	480	000490
MN-17-240/1	3,0	140	30	480	000506
MN-17-290	3,5	190	30	480	5906675026831
MN-17-290/1	3,5	190	30	480	000520



VOLTAGE DETECTOR 100-250V



CONTROL CABINET KEY 10 ENDS



index	pieces	pcs	pcs	5906675
MN-14-210	3	50	100	489513



ALL-PURPOSE INSULATED PLIERS VDE



index	mm	pcs	pcs	5906675
MN-20-080¹	160	6	60	489766
MN-20-081²	180	6	60	489773
MN-20-082³	200	6	60	489780



¹ Zamiennik - MN-20-056

² Zamiennik - MN-20-057

³ Zamiennik - MN-20-058

SIDE-CUTTING INSULATED PLIERS VDE



index	mm	pcs	pcs	5906675
MN-20-158	210	6	60	306148



SIDE-CUTTING INSULATED PLIERS VDE



index	mm	pcs	pcs	5906675
MN-20-092	180	6	60	489810





SIDE-CUTTING INSULATED PLIERS VDE



index	mm	pcs	pcs	5906675
MN-20-098	160	6	60	489889





index				5906675
	mm	pcs	pcs	
MN-20-094	160	6	60	489841



SIDE-CUTTING INSULATED PLIERS VDE





index				5906675
	mm	pcs	pcs	
MN-20-096	160	6	60	489858



SIDE-CUTTING INSULATED PLIERS VDE





index				5906675
	mm	pcs	pcs	
MN-23-057*	160	6	60	489865



WIRE STRIPPING INSULATED PLIERS VDE



*Zamiennik - MN-23-056



index				5906675
	mm	pcs	pcs	
MN-20-086*	160	6	60	489797
MN-20-087	200	6	60	489803



STRAIGHT-NOSE INSULATED PLIERS VDE



*Zamiennik - MN-20-256

index				5906675
	mm	pcs	pcs	
MN-20-088	160	6	60	489827
MN-20-089	200	6	60	489834





CURVED-NOSE INSULATED PLIERS VDE



PLUMBERS INSULATED PLIERS VDE



index				5906757
	mm	pcs	pcs	
MN-20-650	250	6	36	902381







INSULATED ELECTRICIAN'S KNIFE VDE

MN-63-055







MN-63-056

index					5906675
	mm	mm	pcs	pcs	
MN-63-055	180	45	6	60	489575
MN-63-056	190	50	6	60	489582



AUTOMATIC WIRE STRIPPER







index					5906675
	mm	mm ² /MM ²	pcs	pcs	
MN-23-060	180	0,2-6,0	10	60	489520



AUTOMATIC WIRE STRIPPER



index					5906675
	mm	mm ² /MM ²	pcs	pcs	
MN-23-062	170	1,2-3,2	8	48	489537

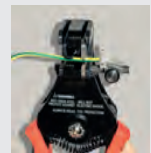



AUTOMATIC WIRE STRIPPER



index					5906675
	mm	mm ² /MM ²	pcs	pcs	
MN-23-064	205	0,15-6	10	60	489544







index				5906757
	mm ² / MM ²	pcs	pcs	
MN-23-079	0,5-6,0	10	50	268029



AUTOMATIC WIRE STRIPPER







index					5906675
	mm	mm ² / MM ²	pcs	pcs	
MN-23-066	125	0,34-6	1	120	489551



WIRE STRIPPING PLIERS



index					5906675
	mm	mm ² / MM ²	pcs	pcs	
MN-23-068	190	8-28	1	100	489568



WIRE STRIPPER







index					5906675
	mm	mm	pcs	pcs	
MN-26-020	250	do 32	10	60	489650



CABLE SHEARS



index					5906675
	mm	mm	pcs	pcs	
MN-26-023	185	do 13	12	72	489667







CABLE SHEARS



CABLE SHEARS



index					5906675
	mm	mm	pcs	pcs	
MN-26-027	250	do 13	6	36	489681

max
60 mm²
ø13 mm

CrMo

**56-60
HRC**

WIRE AND WIRE ROPE CUTTER



index					5906675
	mm	mm	pcs	pcs	
MN-26-025	190	1,2/4,0	10	60	489674

max
ø1,2 mm
SPRING WIRE

max
ø4,0 mm
WIRE ROPE

**SK5
STEEL**

**56-63
HRC**

MULTIFUNCTIONAL PLIERS 6in1



index					5906757
	mm	mm	pcs	pcs	
MN-20-100	200	15	6	60	001978

max
50 mm²
ø15 mm





6 in 1

**55-58
HRC**

**2-COMPONENT
HANDLE**

CRIMPING PLIERS FOR MODULAR CONNECTORS



index					5906675
	mm	type	pcs	pcs	
MN-20-180	195	8P, 6P, 4P	8	48	489599

4P / 6P / 8P



**SK5
STEEL**

**42-48
HRC**

**TPR
handle**

CRIMPING PLIERS







index					5906675
	mm	mm ² /MM ²	pcs	pcs	
MN-20-184	175	0,25-6	6	36	489612

0,25-6 mm²
AWG 24-10

CrMo

**44-48
HRC**





**2-COMPONENT
HANDLE**

index					5906675
	mm	mm ² /MM ²	pcs	pcs	
MN-20-187	225	0,5-6	10	30	489636



CRIMPING PLIERS







index					5906675
	mm	mm ² /MM ²	pcs	pcs	
MN-20-189	220	0,5-16	12	24	489643



CRIMPING PLIERS





index					5906757
	mm	mm ² /MM ²	pcs	pcs	
MN-20-191	140	0,25-2,5	20	80	002067
MN-20-192	140	1,5-6	20	80	002074



CRIMPING PLIERS FOR END SLEEVES





NEW

index				5906757
	mm	pcs	pcs	
MN-20-026	160	6	60	156982
MN-20-027	180	6	48	156999
MN-20-028	200	6	48	157002



ALL-PURPOSE PLIERS FRIENDLY GRIP



index				5906757
	mm	pcs	pcs	
MN-20-126	160	6	60	157019
MN-20-127	180	6	60	157026





SIDE-CUTTING PLIERS FRIENDLY GRIP



STRAIGHT-NOSE TELEPHONE PLIERS FRIENDLY GRIP



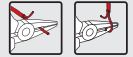

index				5906757
	mm	pcs	pcs	
MN-20-226	160	6	60	157033



CURVED-NOSE TELEPHONE PLIERS FRIENDLY GRIP



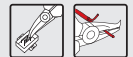

index				5906757
	mm	pcs	pcs	
MN-20-326	160	6	60	157057



FLAT TELEPHONE PLIERS FRIENDLY GRIP



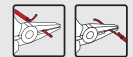

index				5906757
	mm	pcs	pcs	
MN-20-526	160	6	60	157040



PLUMBER'S PLIERS FRIENDLY GRIP





index				5906757
	mm	pcs	pcs	
MN-20-620	250	6	48	165908





STRAIGHT EXTERNAL CIRCIP PLIERS



index		∅			5906757
	mm	mm	pcs	pcs	
MN-20-706	150	8-30	6	60	140714
MN-20-708	175	30-60	6	60	121867
MN-20-710	225	60-100	6	30	263499





index		∅			5906757
	mm	mm	pcs	pcs	
MN-20-716	150	8-30	6	60	140721
MN-20-718	175	30-60	6	60	121881
MN-20-720	225	60-100	6	30	263505



BENT EXTERNAL CIRCLIP PLIERS





index		∅			5906757
	mm	mm	pcs	pcs	
MN-20-726	150	8-30	6	60	140738
MN-20-728	175	30-60	6	60	121898
MN-20-730	225	60-100	6	30	263512



STRAIGHT INTERNAL CIRCLIP PLIERS





index		∅			5906757
	mm	mm	pcs	pcs	
MN-20-736	150	8-30	6	60	140745
MN-20-738	175	30-60	6	60	121874
MN-20-740	225	60-100	6	60	263529



BENT INTERNAL CIRCLIP PLIERS





index				5906757
	mm	pcs	pcs	
MN-20-005	115	6	120	126619



ALL-PURPOSE ELECTRICAL PLIERS



index				5906757
	mm	pcs	pcs	
MN-20-105	115	6	120	126626





SIDE-CUTTING ELECTRICAL PLIERS



END-CUTTING ELECTRICAL PLIERS





index				5906757
	mm	pcs	pcs	
MN-20-165	115	6	120	140554



STRAIGHT-NOSE TELEPHONE PLIERS





index				5906757
	mm	pcs	pcs	
MN-20-205	130	6	120	140561



STRAIGHT NEEDLE-NOSE TELEPHONE PLIERS





index				5906757
	mm	pcs	pcs	
MN-20-265	150	6	120	140585



CURVED-NOSE TELEPHONE PLIERS





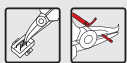



index				5906757
	mm	pcs	pcs	
MN-20-305	130	6	120	140578



FLAT-NOSE ELECTRONIC PLIERS



index				5906757
	mm	pcs	pcs	
MN-20-505	130	6	120	147263





index					5906757
	mm	mm	pcs	pcs	
MN-20-146	165	1,8	6	36	268654
MN-20-147	190	2,0	6	36	268661

CR-V

SIDE-CUTTING PLIERS WITH ARTICULATED JOINT







BASIC TOOLS

index					5906757
	mm	mm/ mm	pcs	pcs	
MN-20-607	180	30	6	72	273122
MN-20-610	250	35	6	60	133556
MN-20-612	300	40	6	48	273115

CR-V

PLUMBER'S PLIERS







index					5906675
	mm	mm	pcs	pcs	
MN-26-077	175	2,0	1	6	349664

CR-V



SIDE-CUTTING PLIERS







index					5906757
	mm	mm	pcs	pcs	
MN-26-016	160	1,5	6	48	245266
MN-26-017	180	2,0	6	48	245273
MN-26-018	200	2,5	6	36	245280

CR-V

PINCERS



index					5906757
	mm	mm	pcs	pcs	
MN-26-066	160	2,0	6	48	245761
MN-26-067	180	2,5	6	36	245778



CR-V

END-CUTTING PINCERS



TOWER PINCERS





index				5906757
	mm	pcs	pcs	
MN-26-120	250	6	60	245303
MN-26-121	275	6	36	245310
MN-26-122	300	6	36	245327
MN-26-123	330	6	36	905559

CR-V

TILE CUTTING PLIERS





index				5906757
	mm	pcs	pcs	
MN-26-218	190	6	48	267343

CR-V



ROOFING PLIERS 250 MM





index				5906757
	mm	pcs	pcs	
MN-26-140	250	6	24	002081
MN-26-141	250	6	24	002098
MN-26-142	250	6	24	002104



CARBON STEEL

LOCK GRIP PLIERS





index		Ø max			5906757
	mm	mm	pcs	pcs	
MN-22-008	185	28	6	60	269255
MN-22-011	225	38	6	60	045156



LOCK GRIP PLIERS



index		Ø max			5906757
	mm	mm	pcs	pcs	
MN-22-012	215	40	6	48	906648



index						5906757
	mm	mm/MM	mm/MM	pcs	pcs	
MN-22-014	215	60	65	6	60	906655

LOCK GRIP PLIERS



index						5906757
	mm	mm/MM	mm/MM	pcs	pcs	
MN-22-018	230	68	75	6	24	906679

LOCK GRIP PLIERS



index						5906757
	mm	inch	mm	pcs	pcs	
MN-25-101	300	1	38	1	36	268685
MN-25-102	410	1½	48	1	18	268692
MN-25-103	535	2	60	1	12	119895

90-DEGREE ADJUSTABLE PIPE WRENCH



CR-V

index						5906757
	mm	inch	mm	pcs	pcs	
MN-25-110	240	½	45	1	48	268708
MN-25-111	315	1	60	1	36	140066
MN-25-112	425	1½	75	1	18	126428
MN-25-113	555	2	90	1	12	140073
MN-25-115	655	3	140	1	5	159808

145-S ADJUSTABLE PIPE WRENCH



CR-V

index						5906757
	mm	inch	mm	pcs	pcs	
MN-25-410	250	1¾	54	1	24	134058
MN-25-412	300	2	60	1	24	134065
MN-25-414	350	2	60	1	24	134089
MN-25-418	450	2½	76	1	12	134072
MN-25-424	600	3½	102	1	8	157224

STILLSON ADJUSTABLE PIPE WRENCH





HAMMERS



The most essential and popular product that comes in handy in most home and workshop repair works is a hammer.

Depending on the application, the best choice appears to be either a hammer with a metal face and a handle made from one piece of forged induction-hardened steel (monoblock) or a hammer with a fiberglass handle. These characteristics guarantee lifetime durability and vibration dampening that significantly increases working comfort. With safety and convenience of use in mind, we have equipped our hammers with durable rubber-coated handles ensuring anti-slip properties, which guarantees secure grip, and a hammer face featuring a magnet which makes it easier to hold the nail being driven.



HAMMER FACE AND HANDLE ◀
MADE FROM ONE PIECE of
induction-hardened material for
supreme product durability

WEDGE-SHAPED INDENTATION ◀
BETWEEN HAMMER CLAWS for
easier nail pulling



▶ **RUBBER-COATED AND
ERGONOMICALLY SHAPED
HANDLE** with anti-slip
properties for secure grip

▶ **MAGNETIC HAMMER FACE,**
making it easier to hold the nail
being driven



CARPENTER'S HAMMER SUPREME



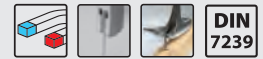

index				5906757
	kg	pcs	pcs	
MN-32-001	0,6	6	24	028071



CARPENTER'S HAMMER MONOBLOCK



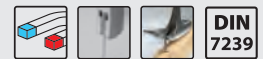

index				5906757
	kg	pcs	pcs	
MN-32-008	0,6	6	24	164789





MASONRY HAMMER - BERLIN PATTERN (WIDE) MONOBLOCK



index				5906757
	kg	pcs	pcs	
MN-32-013	0,6	6	24	268166



MASONRY HAMMER - RHINE PATTERN (NARROW) MONOBLOCK





index				5906757
	kg	pcs	pcs	
MN-32-018	0,6	6	24	268173

CARPENTER'S HAMMER FIBERGLASS





index				5906757
	kg	pcs	pcs	
MN-32-007	0,6	6	24	140141



index	 kg	 pcs	 pcs	5906757
MN-32-012	0,6	6	24	272200



MASONRY HAMMER - BERLIN PATTERN (WIDE) FIBERGLASS



index	 kg	 pcs	 pcs	5906757
MN-32-017	0,6	6	24	272217



MASONRY HAMMER - RHINE PATTERN (NARROW) FIBERGLASS



index	 kg	 pcs	 pcs	5906757
MN-32-022	0,45	6	24	272224



CARPENTER'S HAMMER – AMERICAN PATTERN FIBERGLASS



index	 kg	 pcs	 pcs	5906757
MN-30-603	0,3	6	48	001831
MN-30-605	0,5	6	36	001848
MN-30-608	0,8	6	24	001855
MN-30-610	1,0	6	24	001862
MN-30-615	1,5	6	12	001879
MN-30-620	2,0	6	12	001886

HAMMERS FIBERGLASS





index	 kg	 pcs	 pcs	5906757
MN-30-402	0,2	6	60	273191
MN-30-403	0,3	6	48	273207
MN-30-404	0,4	6	36	273214
MN-30-405	0,5	6	18	273221
MN-30-408	0,8	6	12	273238
MN-30-410	1,0	6	12	273245
MN-30-415	1,5	6	12	273252
MN-30-420	2,0	6	12	273269

HAMMERS





RUBBER Mallet



index				5906675
	kg	pcs	pcs	
MN-31-212	0,35	12	36	024066
MN-31-216	0,45	6	24	024097
MN-31-224	0,68	6	24	024103
MN-31-232	0,90	6	24	024110



Mason's Hammer Fiberglass



index				5906675
	kg	pcs	pcs	
MN-32-103	1,5	6	12	028101

Rubber Protection





index				5906675
	kg	pcs	pcs	
MN-33-005	1,5	20	20	085937



Axes with Wedges



NEW



index		L			5906757
	kg	mm	pcs	pcs	
MN-64-027	1,2	600	6	24	152434
MN-64-029	1,2	800	6	24	152441





Forged Axes



NEW

index		L			5906757
	kg	mm	pcs	pcs	
MN-64-090	0,6	360	1	5	909243
MN-64-092	1,0	500	1	5	909250
MN-64-094	1,25	700	1	5	909267
MN-64-096	1,5	700	1	5	909274







index				5906757
	kg	pcs	pcs	
MN-64-206	0,60	6	24	152434
MN-64-208	0,80	6	24	152441
MN-64-210	1,00	6	24	152458
MN-64-212	1,25	6	12	155510
MN-64-215	1,50	6	12	268241
MN-64-218	1,80	6	12	268234



AXES



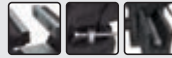

index					5906757
	kg	mm	pcs	pcs	
MN-35-214	7,0	100	1	2	274983
MN-35-215	10,5	125	1	1	274990
MN-35-216	16,5	150	1	1	275003



FITTER'S SWIVEL-BASE VICES





index	L	A			5906757
	mm	mm	pcs	pcs	
MN-37-200	150	50	1	50	246164
MN-37-201	200	50	1	50	147331
MN-37-230	300	80	1	30	147348
MN-37-243	300	120	1	20	147362
MN-37-245	500	120	1	10	147379
MN-37-248	800	120	1	10	150973
MN-37-250	1000	120	1	10	150980
MN-37-255	1500	120	1	6	245587

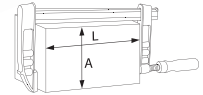
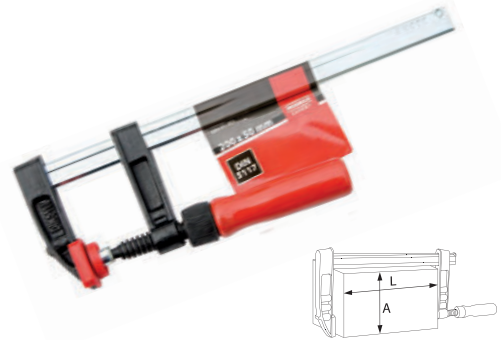

BAR CLAMPS







index	L	A			5906750
	mm	mm	pcs	pcs	
MN-37-260	150	50	1	20	19987
MN-37-262	200	50	1	20	19994
MN-37-263	300	80	1	10	20006
MN-37-264	300	120	1	10	20013
MN-37-265	500	120	1	10	20020
MN-37-266	800	120	1	6	20037
MN-37-270	1000	120	1	6	20044

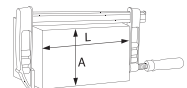

BAR CLAMPS STRONG GRIP



index	L					5906675
	mm	mm	mm	pcs	pcs	
MN-37-353	80	30	35	1	100	426532
MN-37-354	100	40	45	1	40	426549
MN-37-356	170	60	65	1	20	426556
MN-37-359	205	80	85	1	20	426563

SPRING CLAMP



CONNECTING TOOLS

The Modeco Expert branded connecting tools include, above all, staplers, riveters and crimping tools for drywall systems. They are appreciated for their high quality, durability, and convenience in use.

The riveters are intended for joining two independent pieces, such as elements of brackets, shields, or enclosures, by means of rivets and rivet nuts made of steel, stainless steel, aluminium, or copper. They come in handy wherever DIYers, carpenters, installers, and carpenters perform their job.

Staplers are tools used to join materials by puncturing them, and these materials include wood, fabric, paper, or foil. Special clips or nails of different sizes and types are used for this purpose. Their main application is professional upholstery work, but they also come in handy in household and decoration activities.





STAPLE GUNS

One of the most highly valued items in the Modeco Expert portfolio of connecting tools is our metal hand stapler, suitable for a wide selection of pins ranging in sizes from 4 to 14mm, making it possible to join materials of various thicknesses.

It proves most useful at workshops of upholsterers, joiners, roofers, or DIYers. It is typically used for quick joining of different materials, such as wood, fabric, paper, and foil. It features a stepless impact force control function, which makes it possible to adjust the pin driving force depending on its length and material hardness. Another advantage of the stapler is the content viewing capability that allows you to keep track of the number of pins left in the tool magazine without having to stop working.

STEPLESS IMPACT FORCE CONTROL allowing you to adjust the pin driving force depending on the pin length and material hardness

▶ **HANDLE WITH ANTI-SLIP COATING** ensures comfortable and safe use

▶ **STEEL BODY** ensures long tool life



▶ **VIEWING THE CONTENT OF STAPLES** allows you to control the amount of staples in the magazine without having to stop working

index	M53			5906757
	mm	pcs	pcs	
MN-45-109	4-14	10	40	000544
MN-45-110	4-14	10	40	097698



HAND STAPLE GUN

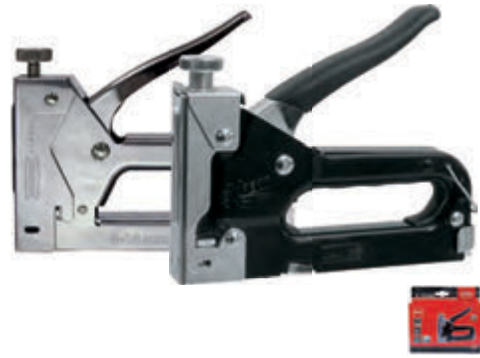

index	M11	M36	M300			5906757
	mm	mm	pcs	pcs	pcs	
MN-45-120	4-14	10-14	14	6	24	272231



HAND STAPLE GUN 4 IN 1



index			5906757
	pcs	pcs	
MN-45-100	20	120	907249

STAPLE REMOVER



index	M53			5906757
	mm	pcs	pcs	
MN-46-106	6	10	10	162457
MN-46-108	8	10	10	162464
MN-46-110	10	10	10	162471
MN-46-112	12	10	10	162488
MN-46-114	14	10	10	162495



STAPLES

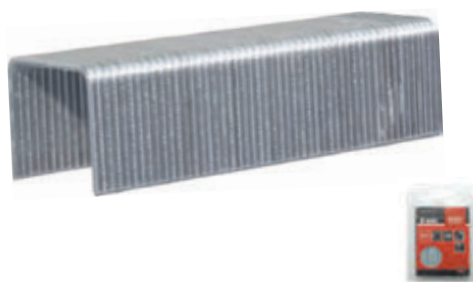

index	M11			5906757
	mm	pcs	pcs	
MN-46-146	6	1	10	272781
MN-46-148	8	1	10	272798
MN-46-150	10	1	10	272804
MN-46-152	12	1	10	272811
MN-46-154	14	1	10	272828



STAPLES



RIGHT ANGLE RIVETER



index				5906757
	mm	pcs	pcs	
MN-40-006	250	12	24	134348



RIGHT ANGLE RIVETER



index				5906675
	mm	pcs	pcs	
MN-40-017	200	5	30	023908



RIGHT ANGLE RIVETER MAXX



index				5906757
	mm	pcs	pcs	
MN-40-007	250	12	24	271456



RIGHT ANGLE RIVETER



index				5906675
	mm	pcs	pcs	
MN-40-018	240	6	24	023915



DUAL POSITION RIVETER MAXX



index				5906757
	mm	pcs	pcs	
MN-40-008	250	1	24	273283



Mechanical tools and automotive products are essential in every garage and workshop. They are typically used by DIYers, but also by professionals in car mechanics, plumbing, and installation.

MECHANICAL TOOLS AND AUTOMOTIVE ARTICLES

It is extremely important that these tools are reliable, made of durable top-quality materials, and ergonomic. And these are precisely the tools delivered by Modeco Expert. The brand's offering comprises adjustable spanners, open-ended spanners, open-ended/box (combination) spanners, open-ended/socket spanners, torque spanners, ratchet spanners, adapters and sockets, intended for all kinds of mechanical and installation works. Users can either customise their tool sets themselves by choosing spanners of specific sizes or use professional ready-made sets. Whatever their choice may be, the products they pick will make their work efficient, satisfying, easy, and faster.





WRENCHES

The most common spanners used, for example, in workshops are combination spanners. They are designed for tightening and loosening of hexagonal bolts and nuts.

The Modeco Expert brand's flagship product is an entire series of combination spanners. Made of high-grade chromium-vanadium steel, they provide long service life and durability. The products feature the MAXXDRIVE system ensuring safe transfer of maximum torque to the bolt or nut. This provides for secure grip of the fastening pieces being screwed in or out. Some additional user advantages are that the products are covered by a 5-year manufacturer's warranty, and that they are manufactured in line with the DIN 3113 standard, which guarantees the high quality of the product make.







▶ **HIGH-GRADE CHROMIUM-VANADIUM STEEL** ensuring long service life and durability

▶ **SATINISED AND POLISHED SURFACE FINISH** protecting spanners against corrosion

MAXXDRIVE SYSTEM ◀ for safe maximum torque transmission to bolts



MANUFACTURED IN LINE WITH DIN 3113 ◀ to guarantee high standard of product workmanship

index						5906757
	mm	mm	mm	pcs	pcs	
MN-50-413	8	10	140	12	288	163331
MN-50-422	10	13	170	12	288	267534
MN-50-428	13	17	200	12	180	163348
MN-50-440	17	19	220	12	96	163355
MN-50-449	19	22	230	12	72	163362
MN-50-453	22	24	245	6	72	267541
MN-50-456	24	27	265	6	48	163379
MN-50-458	27	30	295	6	24	267558
MN-50-462	30	32	295	6	36	163386

CR-V **DIN 3110**

OPEN-END WRENCHES





index				5906757
	pieces	sets	sets	
MN-50-236	6	6	24	163393

CR-V **DIN 3110**

6-PIECE OPEN-END WRENCH SET 6-17 MM





		
mm	mm	mm
6	7	120
8	9	140
10	13	170
12	13	170
14	15	185
16	17	200

index				5906757
	pieces	sets	sets	
MN-50-238	8	6	24	163409

CR-V **DIN 3110**

8-PIECE OPEN-END WRENCH SET 6-22 MM





		
mm	mm	mm
7	6	120
9	8	140
13	10	170
13	12	170
15	14	185
17	16	200
19	18	215
22	20	230

index				5906757
	pieces	sets	sets	
MN-50-240	10	6	12	163416

CR-V **DIN 3110**





10-PIECE OPEN-END WRENCH SET 6-32 MM



		
mm	mm	mm
7	6	120
9	8	140
11	10	155
13	12	170
15	14	185
17	16	200
19	18	215
22	20	230
27	24	260
32	30	295

OPEN-END BOX WRENCHES MAXXDRIVE





index					5906757
	mm	mm	pcs	pcs	
MN-51-406	6	100	12	288	904996
MN-51-407	7	110	12	288	904989
MN-51-408	8	115	12	288	163423
MN-51-409	9	125	12	240	249479
MN-51-410	10	135	12	288	163430
MN-51-411	11	145	12	72	163447
MN-51-412	12	155	12	288	163454
MN-51-413	13	165	12	288	163461
MN-51-414	14	175	12	144	163478
MN-51-415	15	185	12	144	249486
MN-51-416	16	195	12	144	249493
MN-51-417	17	210	12	144	163485
MN-51-418	18	220	12	96	249509
MN-51-419	19	230	12	96	163492
MN-51-421	21	240	6	96	249516
MN-51-422	22	250	6	96	163508
MN-51-424	24	270	6	72	163515
MN-51-427	27	300	6	48	163522
MN-51-430	30	330	6	36	163539
MN-51-432	32	350	6	36	163546





6-PIECE OPEN-END BOX WRENCH SET MAXXDRIVE 8-17 MM





index				5906757
	pieces	sets	sets	
MN-51-236	6	6	24	163553





	
mm	mm
8	115
10	135
12	155
13	165
14	175
17	210

8-PIECE OPEN-END BOX WRENCH SET MAXXDRIVE 8-19 MM



index				5906757
	pieces	sets	sets	
MN-51-238	8	6	24	163560







	
mm	mm
8	115
9	125
10	135
12	155
13	165
14	175
17	210
19	230

12-PIECE OPEN-END BOX WRENCH SET MAXXDRIVE 6-22 MM



index				5906757
	pieces	sets	sets	
MN-51-242	12	6	18	163577



			
mm	mm	mm	mm
6	100	12	155
7	110	13	165
8	115	14	175
9	125	17	210
10	135	19	230
11	145	22	250

index	pieces	sets	sets	5906757
MN-51-250	20	1	6	163584



mm		mm		mm		mm	
6	100	17	210	17	210	17	210
7	110	18	220	18	220	18	220
8	115	19	230	19	230	19	230
9	125	21	240	21	240	21	240
10	135	22	250	22	250	22	250
11	145	24	270	24	270	24	270
12	155	27	300	27	300	27	300
13	165	30	330	30	330	30	330
14	175	32	350	32	350	32	350
15	185						
16	195						

20-PIECE OPEN-END BOX WRENCH SET MAXXDRIVE 6-32 MM



MECHANICAL TOOL

index	pieces	sets	sets	5906675
MN-51-255	25	1	5	327990



mm		mm		mm		mm	
6	100	15	185	23	260	23	260
7	110	16	195	24	270	24	270
8	115	17	210	25	280	25	280
9	125	18	220	26	290	26	290
10	135	19	230	27	300	27	300
11	145	20	235	28	310	28	310
12	155	21	240	30	330	30	330
13	165	22	250	32	350	32	350
14	175						

25-PIECE OPEN-END BOX WRENCH SET MAXXDRIVE 6-32 MM.



index	mm	mm	pcs	pcs	5906757
MN-59-608	8	135	10	300	909816
MN-59-609	9	154	10	200	909823
MN-59-610	10	154	10	200	909830
MN-59-611	11	167	10	200	909847
MN-59-612	12	178	10	180	909854
MN-59-613	13	178	10	180	909861
MN-59-614	14	192	10	90	909878
MN-59-615	15	207	10	120	909885
MN-59-616	16	207	10	100	909892
MN-59-617	17	222	10	100	909908
MN-59-618	18	222	10	100	909915
MN-59-619	19	238	10	60	909922



COMBINATION RATCHET WRENCHES SPEED DRIVE



index	mm	mm	pcs	pcs	5906757
MN-59-710	10	154	10	200	909953
MN-59-713	13	179	10	200	909984
MN-59-717	17	223	10	60	910027
MN-59-719	19	242	10	60	910041



COMBINATION RATCHET WRENCHES WITH PIVOT HEAD SPEED DRIVE



**7-PIECE COMBINATION RATCHET WRENCHES SET
8-19 MM**



index	pieces	sets	sets	5906675
MN-59-657	7	6	24	431024

mm	mm
8	135
10	154
11	167
13	178
15	207
17	222
19	238



**7-PIECE COMBINATION RATCHET WRENCHES SET
8-19 MM**



index	pieces	sets	sets	5906675
MN-59-757	7	6	24	431024

mm	mm
8	142
10	160
11	173
13	193
15	210
17	230
19	248



FLEX HANDLE 1/2" 375 MM



index	inch	mm	pcs	pcs	5906757
MN-55-557	1/2	375	6	24	270961







EXTENSIONS FOR SOCKETS 1/2"



index	inch	mm	pcs	pcs	5906757
MN-55-551	1/2	125	1	100	122345
MN-55-552	1/2	250	1	50	122352



index					5906757
	inch	mm	pcs	pcs	
MN-55-555	1/2	250	1	50	121584



T HANDLE FOR SOCKETS 1/2" 250 MM





index					5906757
	inch	mm	pcs	pcs	
MN-56-010	1/2	570	1	10	097513



DYNAMOMETRIC WRENCH 1/2" 42-210 NM







index					5906757
	inch	mm	pcs	pcs	
MN-55-507	1/4	160	25	100	270947
MN-55-517	1/2	250	10	30	146211



RATCHET WRENCH FOR SOCKETS 1/4", 1/2"







index					5906757
	inch	mm	pcs	pcs	
MN-55-519	1/2	250	5	30	160439



RATCHET WRENCH FOR SOCKETS 1/2"



index					5906757
	inch	mm	pcs	pcs	
MN-55-520	1/2	250	5	30	247840



RATCHET WRENCH FOR SOCKETS 1/2"



9 SOCKET SET WITH RATCHET 1/2" 10-22 MM



index	pieces	pcs	pcs	5906757
MN-57-152	10	1	18	907522



mm
10
12
13
14
15
16
17
19
22

9 SOCKET SET 1/2" 10-22 MM



index	pieces	pcs	pcs	5906757
MN-57-151	9	1	24	907515



mm
10
12
13
14
15
16
17
19
22

9 SOCKET E-STAR SET 1/2" E10-E24



index	pieces	pcs	pcs	5906757
MN-57-153	9	1	24	907539



mm
E10
E11
E12
E14
E16
E18
E20
E22
E24

9 SOCKET TORX SET WITH 1/2" DRIVE T20-T70



index	pieces	pcs	pcs	5906757
MN-57-154	9	1	24	907546



mm	mm
T20	T50
T25	T55
T30	T60
T40	T70
T45	











index			5906675
	sets	sets	
MN-57-318	6	48	000794



		
	mm	inch
	10,0; 11,0; 12,0; 13,0; 14,0; 15,0; 17,0; 19,0; 21,0; 22,0; 24,0;	1/2
	250	1/2
	200; 125	1/2
	250	1/2
	75	1/2
	16; 21	1/2
	360	1/2

index			5906675
	sets	sets	
MN-57-320	6	48	007717



		
	mm	inch
	6,0; 8,0; 10,0; 11,0; 12,0; 13,0; 14,0; 15,0; 17,0; 19,0; 21,0; 22,0; 24,0;	3/8
	250	3/8
	125; 75	3/8
	125	3/8
	75	3/8
	16; 21	3/8
	360	3/8

TOOLKIT 1/2" 18 PCS



TOOLKIT 3/8" 20 PCS











TOOLKIT 1/2" 18 PCS







index			5906675
	sets	sets	
MN-57-323	6	48	047522



		
	mm	inch
	10,0; 11,0; 12,0; 13,0; 14,0; 15,0; 16,0; 17,0; 19,0; 21,0; 22,0; 24,0; 27,0; 30,0; 32,0	1/2
	250	1/2
	200; 125	1/2
	250	1/2
	75	1/2
	16; 21	1/2
	360	1/2

ADJUSTABLE WRENCHES





index					5906757
	mm	mm	pcs	pcs	
MN-53-106	150	20	6	48	273153
MN-53-108	200	25	6	24	146693
MN-53-110	250	32	6	24	146709
MN-53-112	300	35	6	24	146716



WHEEL LUG WRENCH 17, 19, 21, 22 MM



index				5906757
	mm	pcs	pcs	
MN-59-001	17, 19, 21, 22	1	20	910348

index	①	📦	📦	5906757
	pieces	sets	sets	
MN-54-102	10	6	48	157248



mm	mm	mm	mm
1,5	45	5	75
2	50	5,5	80
2,5	55	6	95
3	65	8	105
4	70	10	120

10-PIECE HEX KEY SET 1,5-10 MM



index	①	📦	📦	5906757
	pieces	sets	sets	
MN-54-117	9	6	72	272484



mm	mm	mm	mm
1,5	45	5	75
2	50	6	95
2,5	55	8	105
3	60	10	120
4	65		

9-PIECE BALL-END HEX-KEY SET 1,5-10 MM



index	①	📦	📦	5906757
	pieces	sets	sets	
MN-54-118	9	8	48	157231



mm	mm	mm	mm
1,5	75	5	120
2	80	6	140
2,5	85	8	160
3	95	10	180
4	105		

9-PIECE BALL-END HEX-KEY SET 1,5-10 MM



index	①	📦	📦	5906757
	pieces	sets	sets	
MN-54-119	9	6	60	152427



mm	mm	mm	mm
1,5	75	5,0	120
2,0	80	6,0	140
2,5	85	8,0	160
3,0	95	10,0	180
4,0	105		

9-PIECE BALL-END HEX-KEY SET 1,5-10 MM



index	①	📦	📦	5906757
	pieces	sets	sets	
MN-54-121	9	6	60	902091



mm	mm	mm	mm
1,5	75	5	120
2	80	6	140
2,5	85	8	160
3	95	10	180
4	105		

9-PIECE HEX KEY SET 1,5-10 MM



9-PIECE TORX WRENCH SET T10-T50



index	①	📦	📦	5906757
	pieces	sets	sets	
MN-54-106	9	6	72	272408



mm	↔	mm	↔
T10	45	T30	85
T15	50	T40	95
T20	55	T45	105
T25	65	T50	115
T27	70		

9-PIECE TORX WRENCH SET T10-T5

9-PIECE TORX WRENCH SET
НАБОР 9 КЛЮЧЕЙ ТОРЦЕВЫХ TORX



index	①	📦	📦	5906757
	pieces	sets	sets	
MN-54-116	9	6	36	902015



mm	↔	mm	↔
T10	90	T30	160
T15	100	T40	170
T20	110	T45	200
T25	125	T50	220
T27	140		

9-PIECE BALL-END HEX - KEY SET 1,5-10 MM



index	①	📦	📦	5906757
	pieces	sets	sets	
MN-54-120	9	6	36	272415



mm	↔	mm	↔
1,5	90	4,0	140
2,0	100	5,0	160
2,5	110	6,0	175
3,0	125	8,0	200

ZESTAW KLUCZY IMBUSOWYCH HEX 2-8 MM SCYZORYK 8 CZ.

8-PIECE HEX KEY SET
НАБОР 8 КЛЮЧЕЙ ШЕСТИГРАННЫХ



index	①	📦	📦	5906757
	pieces	sets	sets	
MN-54-131	8	12	72	903036



mm	↔	mm	↔
2	55	5	70
2,5	60	6	75
3	60	7	80
4	65	8	85

6-PIECE BALL-END HEX-KEY SET 2-6 MM



index	①	📦	📦	5906757
	pieces	sets	sets	
MN-54-132	6	12	72	903043

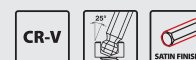

mm	↔	mm	↔
2	55	4	65
2,5	60	5	70
3	60	6	75

index	📄	📦	📦	5906757
	pieces	sets	sets	
MN-54-134	7	12	72	903067



🚫	↔	🚫	↔
mm	mm	mm	mm
T10	55	T27	70
T15	60	T30	75
T20	60	T40	80
T25	65		

7-PIECE TORX WRENCH SET T10-T40



index	📄	📏	📏	nośność/ carrying capacity/ грузоподъем- ностью	📦	📦	5906757
	mm	m	t/tons/Тонны	pcs	pcs		
MN-02-503	35	3	2	1	15	090224	
MN-02-506	50	6	2	1	7	090187	
MN-02-508	50	8	2	1	6	090194	
MN-02-510	50	10	2	1	5	090200	
MN-02-512	50	12	2	1	5	090217	



RATCHET STRAPS

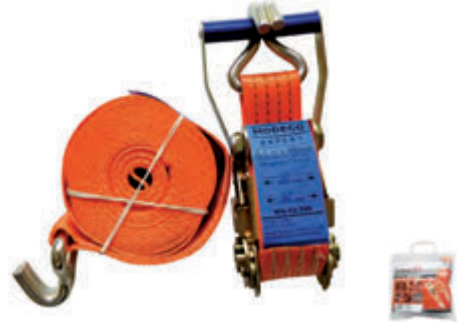

index	📄	📏	📏	nośność/ carrying capacity/ грузоподъем- ностью	📦	📦	5906757
	mm	m	t/tons/Тонны	pcs	pcs		
MN-02-612	30	2	1	1	20	000346	
MN-02-613	30	3	1	1	20	393896	
MN-02-615	30	5	1	1	15	000353	
MN-02-621	60	1	2	1	20	000360	
MN-02-622	60	2	2	1	15	000377	
MN-02-623	60	3	2	1	15	000384	
MN-02-624	60	4	2	1	10	000391	
MN-02-626	60	6	2	1	8	000407	
MN-02-632	90	2	3	1	10	000414	
MN-02-633	90	3	3	1	8	000421	
MN-02-634	90	4	3	1	5	000438	
MN-02-635	90	5	3	1	5	000445	
MN-02-636	90	6	3	1	5	000452	
MN-02-643	120	3	4	1	8	000773	
MN-02-644	120	4	4	1	6	000780	
MN-02-645	120	5	4	1	6	000797	
MN-02-646	120	6	4	1	6	000803	

EYE WEBBING SLING



index	📄	📦	📦	5906757
	ml/мл	sets	sets	
MN-09-080	400	1	15	000810



OIL FOR DRILLING AND CUTTING



ZINC SPRAY 400 ML



index	ml/мл	sets	sets	5906757
MN-09-083	400	1	45	000841

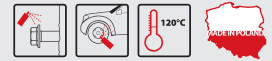

UNIVERSAL LUBRICANT SPRAY 400ML



index	ml/мл	sets	sets	5906757
MN-09-092	400	1	15	270992

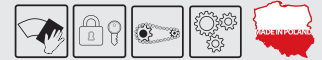

SILICON GREASE 400ML



index	ml/мл	sets	sets	5906757
MN-09-095	400	1	15	064420



GRAPHITE GREASE 400ML



index	ml/мл	sets	sets	5906757
MN-09-096	400	1	15	064437





Measuring instruments must be accurate because they are often used in renovation and finishing work, as well as on construction sites. They make it easy to determine and check the dimensions of parts or clearances.

MEASURING TOOLS

Modeco Expert delivers a wide range of measuring tools which allow you to quickly and conveniently check the length of cut pieces or measure distances. These include high-quality and high-precision measuring tapes, retractable and folding measures, callipers, and angle gauges. They give you the certainty that no mistakes or errors are made during DIY work at home or at the construction site.

Users truly appreciate working with the Modeco Expert measuring tools whose quality and accuracy are confirmed by the certificates they have received and the standards they meet.





TAPE RULES

Retractable measuring tapes perform an important function in construction or any kinds of renovation works. They are designed for measuring distances that do not exceed 10 metres.

Our construction measuring tapes are used by both builders and do-it-yourselfers. In order to meet the customers' requirements, the Modeco Expert offering includes the most accurate measuring tape, PRO CHROM, which complies with the stringent conditions of the EU standards for Class I accuracy. It proves indispensable in most construction and repair works. It features a special tape coating which prolongs its service life and reduces the potential abrasion wear. On top of that, the white measuring tape is well visible during measurements. It is available in three lengths: 3m, 5m, and 8m.

▶ **RUBBERISED CASING**
for increased shock
resistance

CHROMIUM-PLATED BODY ◀
for maximum durability



▶ **SLIDE LOCK**
ensuring improved
retraction control
and extended life

WHITE MEASURING TAPE ◀
ensuring good visibility
during measurements

▶ **MEASURING TAPE
COMPLIANT WITH
STRINGENT REQUIREMENTS
OF EU STANDARDS AND
HIGH ACCURACY CLASS**
(admissible measuring error of
+0.3mm per 2m)



**SPECIAL ADDITIONAL TAPE
COATING** ◀
for extended service
life and reduced abrasion wear

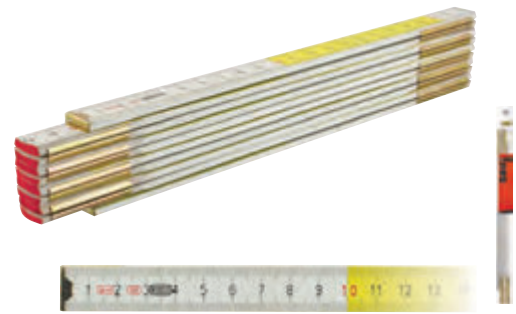

index				5906757
	m	pcs	pcs	
MN-80-151	1	10	240	147317
MN-80-152	2	5	120	147324

FOLDING RULERS





index				5906757
	m	pcs	pcs	
MN-80-162	2	5	100	903029





FOLDING RULER PVC



index				5906675
	m	pcs	pcs	
MN-80-171	1	10	240	034553
MN-80-172	2	5	120	375786





FOLDING RULERS SUPREME



index				5906675
	m	pcs	pcs	
MN-80-212	2	12	120	019925

FOLDING RULER



index					5906675
	m	mm	pcs	pcs	
MN-81-023	3	16	12	72	415000
MN-81-025	5	25	12	72	325064
MN-81-028	8	25	6	48	415017
MN-81-030	10	25	6	48	415031



TAPE RULES SILVER LINE



TAPE RULES SUPREME



index					5906757
	m	mm	pcs	pcs	
MN-81-113	3	16	12	120	148369
MN-81-115	5	19	12	120	148376



TAPE RULES BASIC



index					5906757
	m	mm	pcs	pcs	
MN-81-132	2	16	12	120	162556
MN-81-133	3	16	12	120	162563
MN-81-135	5	25	12	60	162570
MN-81-137	7,5	25	12	60	162587



TAPE RULES BIG STOP



index					5906757
	m	mm	pcs	pcs	
MN-81-143	3	19	10	120	265905
MN-81-145	5	25	10	120	265912
MN-81-148	8	25	10	60	265929



TAPE RULES FRIENDLY GRIP



index					5906757
	m	mm	pcs	pcs	
MN-81-152	2	16	12	144	151352
MN-81-153	3	16	12	144	151345
MN-81-155	5	19	12	72	151369
MN-81-156	5	19	12	72	266209
MN-81-158	8	25	12	48	151376

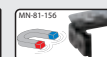





TAPE RULES METAL PROF



index					5906675
	m	mm	pcs	pcs	
MN-81-183	3	16	12	120	024547
MN-81-185	5	19	12	72	024554
MN-81-186	5	19	12	72	119106
MN-81-188	8	25	6	48	024561







index					5906757
	m	mm	pcs	pcs	
MN-81-203	3	16	12	120	121508
MN-81-205	5	19	12	120	121515
MN-81-208	8	25	6	48	121522



TAPE RULES PRO-CHROM







index					5906757
	m	mm	pcs	pcs	
MN-81-211	10	13	5	30	145689
MN-81-221	20	13	5	20	145696
MN-81-231	30	13	5	20	145702



MEASURING TAPE







index					5906757
	m	mm	pcs	pcs	
MN-81-232	30	13	5	20	151963
MN-81-252	50	13	5	20	151970







SURVEYOR'S MEASURING TAPES FRIENDLY GRIP



index					5906757
	mm	mm	pcs	pcs	
MN-83-020	165	250	6	48	161511
MN-83-022	180	300	6	30	161528
MN-83-024	195	350	6	30	161535
MN-83-026	210	400	6	30	161542

SQUARE RULER



index						5906757
	pieces	mm	mm	pcs	pcs	
MN-83-030	1	100	300	20	60	000872



COMBINATION SQUARE



SQUARE "T"



index						5906757
	pieces	mm	mm	pcs	pcs	
MN-83-040	1	300	600	6	36	000858
MN-83-042	1	500	1000	6	36	000865



ROOFING SQUARE RULER



index					5906757
	mm	mm	pcs	pcs	
MN-83-050	400	600	6	36	272965

CARPENTER'S SQUARE



index						5906757
	pieces	mm	mm	pcs	pcs	
MN-83-055	1	200	300	10	100	000896
MN-83-057	1	400	600	9	27	000902



CARPENTER'S SQUARE 185X185 MM



index					5906757
	mm	mm	pcs	pcs	
MN-83-100	185	185	1	36	000889







CARPENTER'S SQUARE 300X300 MM



index					5906675
	mm	mm	pcs	pcs	
MN-83-102	300	300	10	30	497389



index					5906757
	mm	mm	pcs	pcs	
MN-85-100	150	0,01	6	48	098510
MN-85-101	150	0,01	12	48	902671

stainless steel
graduation mm and inch

ELECTRONIC SLIDE CALIPERS

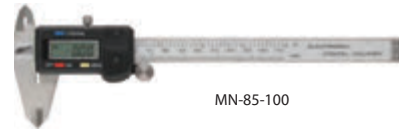

MN-85-100

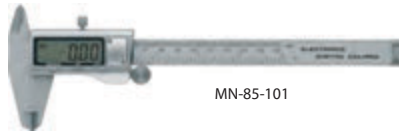

MN-85-101

CONSTRUCTION TOOLS

Work organisation at construction sites or even at home, during renovation work, is a very important stage that actually marks the onset of every project. What matters is to make sure that the high-quality tools delivered by Modeco Expert are securely stored in appropriate conditions, so that they can serve their purpose for a long time.

Construction tools prove useful at every stage of construction work. Additionally, once the project is completed, you can use the tools to create your own structures in the garden or workshop. But it is important to remember that they should be properly secured and maintained, as it affects the comfort and quality of work. The Modeco Expert offering of construction tools is extremely diverse and wide. Some more products worth special attention are high-quality construction floats intended for sanding, smoothing, and troweling of plasters, as well as for finishing of plasters, mortars, and adhesives. To make sure that the surface thus obtained is even, it is necessary to set a level or plumb line using a spirit level. When the work is done, we recommend you to store smaller tools in dedicated containers.



LEVELS

Levels with vials are measuring tools that can be used to mark out a level, a plumb line, an angle of 45°, or an inclination on a surface. They differ in length, number and type of vials, number of handgrips, and cross-section.

The Modeco Expert Basic spirit levels with horizontal and vertical vials are specifically intended for construction work. Their high measurement accuracy of 0.4 mm/m is guaranteed by the shockproof vials. The level vial is made according to an innovative design that ensures easy and quick reading, regardless of the viewing angle. It also has additional rings, as a standard feature, allowing you to establish a 2.3% inclination.

Modeco Expert is committed to high quality, which is why our spirit levels are covered by a lifetime warranty on the vial gluing and the side shock absorbers. Powder coating additionally protects the tool's corrosion-resistant aluminium profile against scratches, while the profile ribbing increases torsion resistance and provides increased resistance to bending. Having gentle shapes and no sharp edges, the tool is extremely easy to clean.

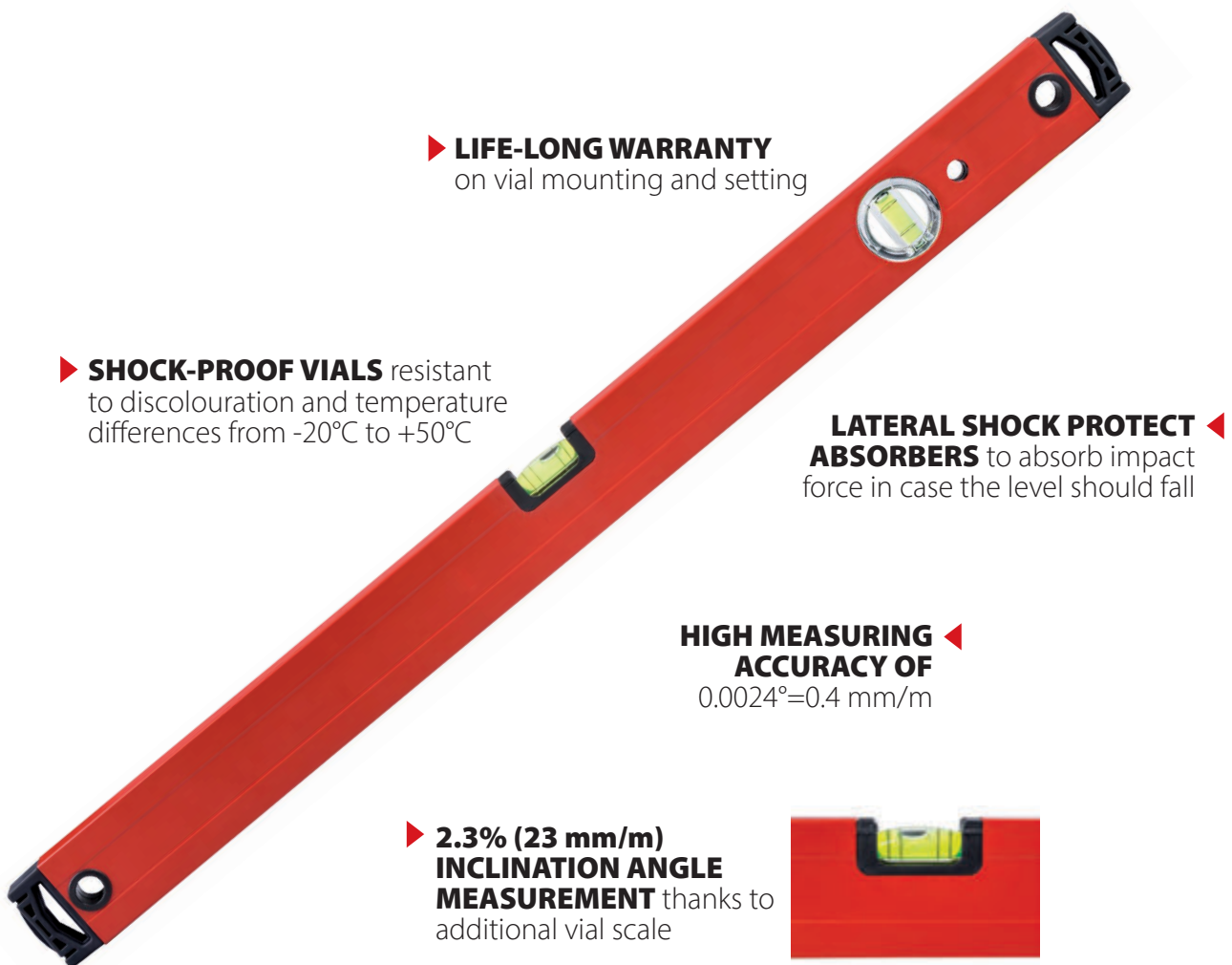

▶ **LIFE-LONG WARRANTY**
on vial mounting and setting

▶ **SHOCK-PROOF VIALS** resistant to discolouration and temperature differences from -20°C to +50°C

LATERAL SHOCK PROTECT ◀
ABSORBERS to absorb impact force in case the level should fall

HIGH MEASURING ◀
ACCURACY OF
0.0024°=0.4 mm/m

▶ **2.3% (23 mm/m) INCLINATION ANGLE MEASUREMENT** thanks to additional vial scale



index	cm	pcs	pcs	5906757
MN-70-556	60	1	5	464961
MN-70-558*	80	1	5	464978
MN-70-560*	100	1	5	464985
MN-70-562*	120	1	5	464992
MN-70-565*	150	1	5	001923
MN-70-570*	200	1	5	001930

*2 uchwyty



ANODIZED LEVELS 90° 0° 45° MAX LEVEL GOLD

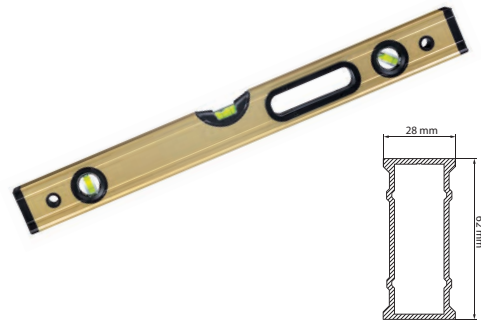

index	cm	pcs	pcs	5906675
MN-70-536	60	1	5	464909
MN-70-538	80	1	5	464916
MN-70-540	100	1	5	464923
MN-70-542	120	1	5	464930
MN-70-545	150	1	5	464947
MN-70-550	200	1	5	464954



ANODIZED LEVELS 90° 0° MAX LEVEL SILVER

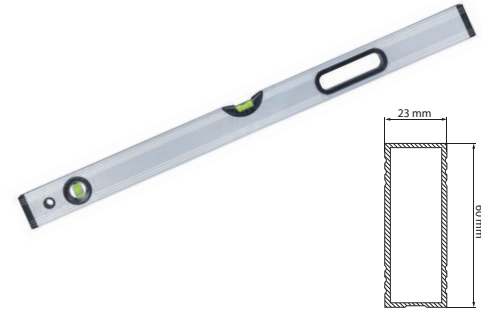

index	cm	pcs	pcs	5906757
MN-70-502	25	5	5	002128



ANODIZED LEVELS 90° 0° SILVER



NEW

index	cm	pcs	pcs	5906675
MN-70-504	40	1	5	464831
MN-70-506	60	1	5	464848
MN-70-508	80	1	5	464855
MN-70-510	100	1	5	464862
MN-70-512	120	1	5	464879
MN-70-515	150	1	5	464886
MN-70-520	200	1	5	464893



LEVELS BASIC 90° 0°

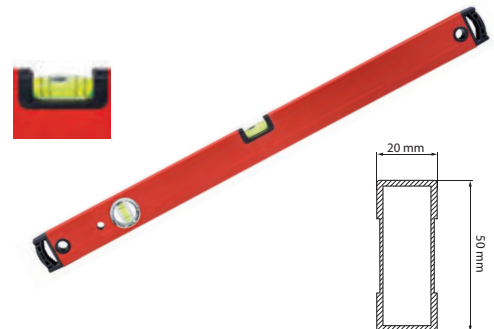

index	cm	pcs	pcs	5906757
MN-71-122	200	1	5	909137
MN-71-127	250	1	5	909144
MN-71-130	300	1	5	909151



BRICKLAYER STAFFS WITH 2 LEVEL WINDOWS



BRICKLAYER STAFFS WITH 2 LEVEL WINDOWS AND 2 HOLDERS

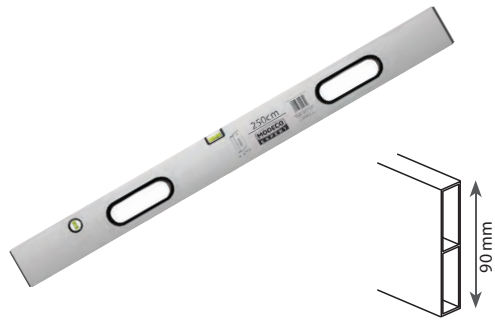

index	cm	pcs	pcs	5906757
MN-71-223	200	1	5	270480
MN-71-227	250	1	5	270497
MN-71-232	300	1	5	270503



BRICKLAYER'S TRAPEZOID STAFFS



index	cm	pcs	pcs	5906757
MN-71-317	150	1	5	270510
MN-71-322	200	1	5	270527
MN-71-327	240	1	5	270534



BRICKLAYER'S SQUARES



index	mm	mm	pcs	pcs	5906757
MN-83-060	600	400	1	5	274877
MN-83-062	1000	500	1	5	274891



BRICKLAYER'S SQUARE



index	mm	mm	pcs	pcs	5906757
MN-83-068	1000	1000	1	5	000995



SANDING SPONGES





index	mm	grain size	pcs	pcs	5906675
MN-73-040	100x70x25	P40	1	250	089188
MN-73-041	100x70x25	P60	1	250	494265
MN-73-042	100x70x25	P80	1	250	494272
MN-73-043	100x70x25	P100	1	250	494289
MN-73-044	100x70x25	P120	1	250	494296
MN-73-045	100x70x25	P150	1	250	494302
MN-73-046	100x70x25	P180	1	250	497921
MN-73-047	100x70x25	P220	1	250	497938



NEW





index		grain size			5906675
	mm		pcs	pcs	
MN-73-050	100x70/50x25	P60	1	250	494319
MN-73-051	100x70/50x25	P80	1	250	494326
MN-73-052	100x70/50x25	P100	1	250	494333
MN-73-053	100x70/50x25	P120	1	250	494340
MN-73-054	100x70/50x25	P150	1	250	494357
MN-73-055	100x70/50x25	P180	1	250	497945



SANDING SPONGES



NEW



index		grain size			5906675
	mm		pcs	pcs	
MN-73-060	100x100x12	P40	1	250	498041
MN-73-061	100x100x12	P60	1	250	498058
MN-73-062	100x100x12	P80	1	250	498065
MN-73-063	100x100x12	P100	1	250	498072
MN-73-064	100x100x12	P120	1	250	498089
MN-73-065	100x100x12	P150	1	250	498096
MN-73-066	100x100x12	P180	1	250	498102
MN-73-067	100x100x12	P220	1	250	498119



SANDING SPONGES 2 PCS





NEW

index					5906675
	mm		pcs	pcs	
MN-72-100	130		20	200	024578



SILICONE FILLER KNIFE



index					5906757
	mm		pcs	pcs	
MN-72-076	60		1	20	901698
MN-72-078	80		1	10	901780
MN-72-080	100		1	10	161283

STAINLESS STEEL SCRAPER PROFI



index					5906675
	mm		pcs	pcs	
MN-72-130	40		1	20	478524
MN-72-131	60		1	20	478531
MN-72-132	80		1	20	478548
MN-72-133	100		1	20	478555
MN-72-134	120		1	20	478562
MN-72-135	150		1	20	478579

STAINLESS STEEL SCRAPER



two-component handle

STAINLESS STEEL SCRAPER WITH PH2 BIT



index				5906675
	mm	pcs	pcs	
MN-72-136	150	1	20	478586



STAINLESS STEEL PLASTER SMOOTHER



index				5906675
	mm	pcs	pcs	
MN-72-370	300	1	10	478593



ostrze stalowe 0,5 mm
prowadnice aluminiowe
rączka dwukomponentowa

steel 0.5 mm blade
aluminium guide
two-component handle

стальное лезвие 0,5 мм
алюминиевые
направляющие
двухкомпонентная ручка

STAINLESS STEEL PLASTER SMOOTHER



index				5906675
	mm	pcs	pcs	
MN-72-371	350	1	10	478609
MN-72-372	400	1	10	478616
MN-72-373	450	1	10	478623
MN-72-374	500	1	10	478630
MN-72-375	600	1	10	478647



SKIMMING SPATULAS PVC 0,3 MM



NEW

index				5906675
	mm	pcs	pcs	
MN-72-502	250	2	2	469836
MN-72-504	400	2	2	469843
MN-72-506	600	2	2	469850
MN-72-508	800	2	2	469867
MN-72-510	1000	2	2	469874





SKIMMING SPATULAS ALU 0,3 MM



NEW

index				5906757
	mm	pcs	pcs	
MN-72-522	250	2	2	002142
MN-72-524	400	2	2	469843
MN-72-526	600	2	2	002166
MN-72-528	800	2	2	002173
MN-72-530	1000	2	2	002180

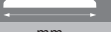



index				5906675
	mm	pcs	pcs	
MN-72-542	250	2	2	469904
MN-72-544	400	2	2	469911
MN-72-546	600	2	2	469928
MN-72-548	800	2	2	469935
MN-72-550	1000	2	2	469942



SKIMMING SPATULA BLADES 0,3 MM



NEW



index				5906675
	m	pcs	pcs	
MN-72-580	1,3-2,4	6	24	469973



TELESCOPIC POLE 1,3-2,4 M



NEW



index				5906675
	mm	pcs	pcs	
MN-72-581	180	1	4	469980



ADAPTER FOR SKIMMING SPATULA



NEW





index				5905629
	mm	pcs	pcs	
MN-74-318	80	1	10	031204
MN-74-320	100	1	10	031297



STAINLESS STEEL TROWELS FOR PLASTER



beech handle
blade: 1,3mm

index					5906675
	mm	mm	pcs	pcs	
MN-74-210	60	115	1	30	478708
MN-74-211	80	115	1	30	478715
MN-74-212	100	130	1	30	478722





STAINLESS STEEL TROWELS FOR PLASTER



two-component grip

STAINLESS STEEL TRAPEZOID TROWELS





index				5905629
	mm	pcs	pcs	
MN-74-328	180	1	10	031709



beech handle
blade: 1,3mm

TRAPEZOID TROWEL GROUND - WELDED





index				5906675
	mm	pcs	pcs	
MN-74-160	180	1	50	486932



two-component
blade:
- steel
- hardened

STAINLESS STEEL TRAPEZOID TROWELS WITH RIVET





index				5906675
	mm	pcs	pcs	
MN-74-197	140	1	30	486970
MN-74-198	160	1	30	486987
MN-74-199	180	1	30	486994



two-component handle

TRIANGLE TROWELERS





index				5906757
	mm	pcs	pcs	
MN-74-218	180	1	20	072251
MN-74-219	190	1	20	072268
MN-74-220	200	1	20	072275
MN-74-221	210	1	20	072282



wood handle
edge:
- hardened
- 1,2mm



TRIANGLE TROWELERS



index				5906675
	mm	pcs	pcs	
MN-74-163	160	1	50	486956
MN-74-164	200	1	50	486963



two-component grip
edge:
- steel
- hardened

index				5906675
	mm	pcs	pcs	
MN-74-303	8	1	80	478739
MN-74-304	10	1	80	478746
MN-74-305	12	1	80	486451



two-component grip

index				5906757
	mm	pcs	pcs	
MN-74-208	60x100	1	30	900721



two-component grip

index				5906757
	mm	pcs	pcs	
MN-74-209	60x100	1	30	900738



two-component grip

TROWELS FOR PLASTER



TROWELS FOR INTERNAL EDGES



TROWELS FOR EXTERNAL EDGES



CONSTRUCTION FLOATS

Construction floats are tools widely used in renovation and construction works. They are used for applying, trowelling, grinding and smoothing mortars, adhesives, plasters and finishing coats.

Each user - a DIY enthusiast, a tiler, a painter and a bricklayer, will appreciate the high-quality workmanship of the floats and the fact that each of them, regardless of the type and the purpose, has an ergonomic, two-component and cambered handle. This is what improves the comfort of work, which is extremely important in the case of construction and finishing works. The Modeco Expert float with a specially made durable grater is designed for grinding polystyrene boards. It is made of hardened plastic, which ensures rigidity of the structure during operation. It is distinguished by a lightweight, through-hole design that ensures easy cleaning and a longer tool life.

- ▶ **ERGONOMIC, TWO-COMPONENT AND CAMBERED HANDLE** improves the comfort of work

- ◀ **FLOAT WITH A SPECIALLY MADE DURABLE GRATER** is designed for grinding polystyrene boards



- ◀ **LIGHTWEIGHT, THROUGH-HOLE DESIGN** that ensures easy cleaning and a longer tool life

- ▶ **MADE OF HARDENED PLASTIC,** which ensures rigidity of the structure during operation

index					5906757
	mm	mm	pcs	pcs	
MN-73-260	380	130	1	14	128811
MN-73-380	480	130	1	14	150263
MN-73-370	580	130	1	14	159600
MN-73-395	680	130	1	14	271487



beech, varnish handle

STAINLESS STEEL FLOATS



CONSTRUCTION TOOLS

index						5906757
	mm	mm	mm	pcs	pcs	
MN-73-386	480	130	6 x 6	1	14	152298
MN-73-388	480	130	8 x 8	1	14	152304
MN-73-390	480	130	10 x 10	1	14	152311



beech varnish handle
7 bolts fastening

STAINLESS STEEL SERRATED FLOATS



index					5906757
	mm	mm	pcs	pcs	
MN-73-400	280	130	1	24	158252



beech handle

STAINLESS STEEL SERRATED FLOATS



index						5906757
	mm	mm	mm	pcs	pcs	
MN-73-406	280	130	6 x 6	1	24	158276
MN-73-408	280	130	8 x 8	1	24	158283
MN-73-410	280	130	10 x 10	1	24	158290



beech handle

STAINLESS STEEL SERRATED FLOATS



index			5906757
	pcs	pcs	
MN-73-420	1	10	001350

2 pcs
180x130x2 mm and 135x90x2 mm

FLOATS







SPATULA



index	 mm	 mm	 pcs	 pcs	5906757
MN-73-421	50, 75, 100, 120 mm		1	10	001367

STAINLESS STEEL FLOATS







index	 mm	 mm	 pcs	 pcs	5906675
MN-73-330	270	130	1	30	478654



tarnamid handle
two-component grip

STAINLESS STEEL SERRATED FLOATS







index	 mm	 mm	 mm	 pcs	 pcs	5906675
MN-73-336	270	130	6x6	1	30	478661
MN-73-338	270	130	8x8	1	30	478678
MN-73-340	270	130	10x10	1	30	478685
MN-73-339	270	130	12x12	1	30	001961
MN-73-341	270	130	R10	1	30	478692



tarnamid handle
two-component grip

PACA NIERDZEWNA "WENECKA"







index	 mm	 mm	 pcs	 pcs	5906675
MN-73-371	200	85	1	30	486925







aluminium handle
two-component grip
ensures streak-free
finishing of venetian
plasters (does not
leave smudges)

PLASTIC PLASTERING FLOAT



index	 mm	 mm	 pcs	 pcs	5906757
MN-73-102	280	130	1	14	001091

for traditional and
structural plasters





index	 mm	 mm	 mm	 pcs	 pcs	5906757
MN-73-106	280	140	8	1	10	001039



do fugowania płytek ceramicznych for ceramic tile grouting для фуговки плитки

PLASTIC FLOAT WITH RUBBER







index	 mm	 mm	 mm	 pcs	 pcs	5906757
MN-73-107	250	100	10	1	11	001077



for tiling works

PLASTIC FLOAT WITH PROFILED RUBBER







index	 mm	 mm	 mm	 pcs	 pcs	5906757
MN-73-115	280	140	18	1	15	001008



for tile cleaning after grouting

PLASTIC FLOAT WITH FOAM RUBBER







index	 mm	 mm	 mm	 pcs	 pcs	5906757
MN-73-130	280	140	8	1	10	001046



for traditional plasters

PLASTIC FLOAT WITH FLEECE



index	 mm	 mm	 mm	 pcs	 pcs	5906757
MN-73-160	280	140	30	1	14	001015







for tile cleaning after grouting

PLASTIC FLOAT WITH HYDRO SPONGE 30 MM



PLASTIC FLOAT WITH HYDRO SPONGE 30 MM







index						5906757
	mm	mm	mm	pcs	pcs	
MN-73-162	280	140	30	1	14	001022



for tile cleaning after grouting

PLASTIC FLOAT WITH SPONGE 40 MM







index						5906757
	mm	mm	mm	pcs	pcs	
MN-73-165	280	140	40	1	10	001053



for tile cleaning after grouting

ALUMINUM FLOAT WITH – RUBBER SPONGE 18 MM







index						5906757
	mm	mm	mm	pcs	pcs	
MN-73-176	400	200	18	1	5	197197



PLASTIC FLOAT FOR POLYSTYRENE FOAM GRINDING







index					5906757
	mm	mm	pcs	pcs	
MN-73-178	380	160	1	12	001060



PLASTER SCRAPER



index					5906675
	mm	mm	pcs	pcs	
MN-73-180	360	220	1	5	197067



index					5906675
	mm	mm	pcs	pcs	
MN-73-182	450	90	1	5	197180



ALUMINIUM WALL PLANE





index					5906675
	mm	mm	pcs	pcs	
MN-73-185	285	145	1	30	001084



PLASTER SCRAPER



MN-73-194



index				5906757
	pcs	pcs	pcs	
MN-73-193	250	1	15	161252
MN-73-194	500	1	10	161269



AIR BLEED ROLLERS







MN-73-193

index				5906675
	litr/ liter/ литр	pcs	pcs	
MN-79-221	24	1	1	064581



TILING KIT 24 L



index						5906757
	mm	mm	mm	pcs	pcs	
MN-75-071	600	165	16	1	1	275645



45 degree angle
steel base
bearings
light structure
2 solid steel
guides 20x10mm
Cutting wheel ø16mm

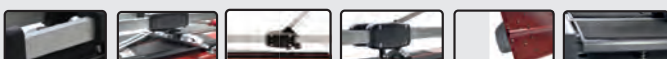

TILE CUTTERS



TILE CUTTERS



index						5906757
	mm	mm	mm	pcs	pcs	
MN-75-242	600	200	16	1	1	051116
MN-75-243	800	200	16	1	1	051130



square
steel base
shock absorber
2 solid steel
guides 20x10mm
Cutting wheel ø8mm



TILE CUTTERS



index						5906757
	mm	mm	mm	pcs	pcs	
MN-75-246	600	265	16	1	1	060576
MN-75-247	800	265	16	1	1	060583



bearings
shock absorber
45° angle
steel base
hinged base
cushioned base
2 solid rectangular guide 25x12mm
the support for bigger tiles
cutting wheel ø8mm



TILE CUTTERS



index						5906757
	mm	mm	mm	pcs	pcs	
MN-75-286	600	265	16	1	1	268418
MN-75-288	800	265	16	1	1	268425
MN-75-290	1200	265	16	1	1	909328



square
steel base
shock absorber
2 solid aluminium guides
30x12mm
Cutting wheel ø8mm



CUTTING WHEELS FOR TILE CUTTERS





index						5906757
	mm	mm	mm	pcs	pcs	
MN-75-502	15	6	1,5	20	200	157606
MN-75-503	16	6	3,0	20	200	157613
MN-75-504	22	6	2,0	20	200	157620



SPARE TILE CUTTING KNIFE 500, 600, 800, 1200 MM





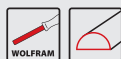

index			5906757
	pcs	pcs	
MN-75-511	20	20	163157

index				5906675
	mm	pcs	pcs	
MN-65-148	150	10	100	014517



HALF ROUND TUNGSTEN FILE 150 MM





index						5906675
	mm	mm	pcs	pcs	opak.	
MN-76-130	2	4	2	10	100	014531



SCRAPER WITH TWO TUNGSTEN BLADES







index		grain size			5906675
	mm		pcs	pcs	
MN-76-320	95x60x30	P60	20	80	494203
MN-76-322	95x60x30	P120	20	80	494210
MN-76-324	95x60x30	P200	20	80	494227
MN-76-326	95x60x30	P400	20	80	494234



DIAMOND HAND BLOCKS







index					5906757
	mm	pcs	pcs	pack	
MN-76-016	1,0	200	1	100	5906675271569
MN-76-000	1,5	200	1	100	166745
MN-76-001	2,0	200	1	100	110830
MN-76-002	2,5	200	1	100	110847
MN-76-003	3,0	150	1	100	110854
MN-76-004	4,0	100	1	100	110861
MN-76-005	5,0	100	1	100	110878

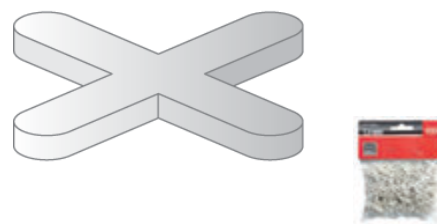

TILE SPACERS



index					5906757
	mm	pcs	pcs	pack	
MN-76-016/C	1,0	200	90	90	5906675271569
MN-76-000/C	1,5	200	90	90	166745
MN-76-001/C	2,0	200	90	90	110830
MN-76-002/C	2,5	200	90	90	110847
MN-76-003/C	3,0	150	90	90	110854
MN-76-011/C	-	50	90	90	268203
MN-76-017/C	1,0; 1,5; 2,0; 2,5; 3,0 + klin	50-200	90	90	271569

15 bags on a clipstrip
6 clipstrips in the
package



TILE SPACERS

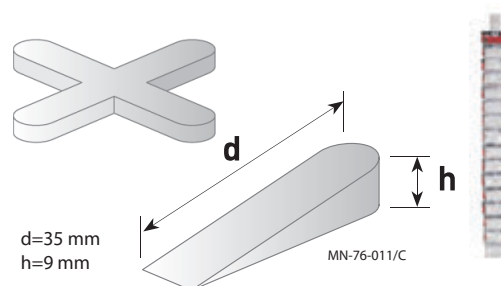

TILE WEDGE SPACERS

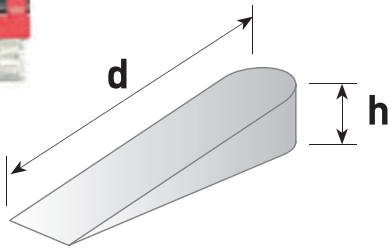

index	ⓘ	d	h				5906757
		mm		pcs	pcs	pack	
MN-76-010	small	27	6	100	1	100	110885
MN-76-011	big	35	9	50	1	100	905726



TILE SPACERS TO CLINKER



index		mm	pcs	pcs	pack	5906675
MN-76-013		8	30	1	100	078342
MN-76-014		10	30	1	100	078359



LIGHT DUTY APPLICATION GUN



index		inch(mm)	pcs	pcs	5906757
MN-79-011		9 (230)	12	24	155350



LIGHT DUTY APPLICATION GUN 9"/230 MM



index		inch(mm)	pcs	pcs	5906757
MN-79-012		9 (230)	6	24	903371



LIGHT DUTY APPLICATION GUN 9"/230 MM



index		mm	pcs	pcs	5906675
MN-79-013		230	6	24	023847







index				5906757	
	pcs	m	pcs	pcs	
MN-79-018	2	30	6	24	268487







BRICK LINE 30M WITH BLUE CHALK + 115G CHALK



index		section			5906757
	mm		pcs	pcs	
MN-88-015	180		12	144	271098
MN-88-018	240		12	144	271104









CARPENTER'S PENCILS



index		section			5906757
	mm		pcs	pcs	
MN-88-022	180		12	144	271111
MN-88-026	240		12	144	271128

MASONRY PENCILS



index					5906757
	mm		pcs	pcs	
MN-88-032	120		12	432	271142
MN-88-033	120		12	432	900219
MN-88-034	120		12	432	900226
MN-88-035	120		12	432	900233
MN-88-036	120		12	432	900226

CHALK

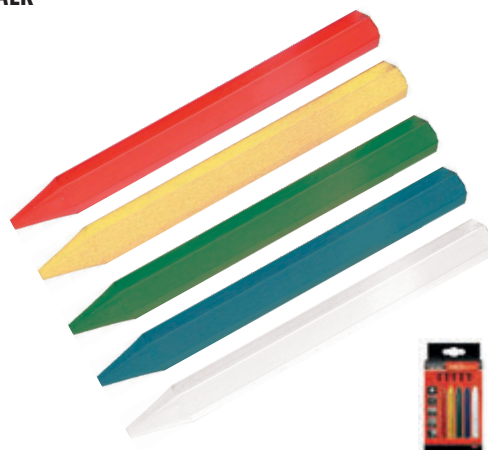

OIL CONSTRUCTION MARKER



index	mm		pcs	pcs	5906757
MN-88-080	2-3,6		1	20	001107
MN-88-081	2-3,6		1	20	001121
MN-88-082	2-3,6		1	20	001145
MN-88-083	2-3,6		1	20	001169
MN-88-080/T	2-3,6		12	72	001114
MN-88-081/T	2-3,6		12	72	001138
MN-88-082/T	2-3,6		12	72	001152
MN-88-083/T	2-3,6		12	72	001176



CHALK MARKER



index	mm		pcs	pcs	5906757
MN-88-090	2-3		1	20	001183
MN-88-091	2-3		1	20	001190
MN-88-090/T	2-3		10	50	001220
MN-88-091/T	2-3		10	50	001237







PERMANENT MARKER



index	mm		pcs	pcs	5906757
MN-88-100	1,5-3		1	20	001206
MN-88-101	1,5-3		1	20	001213
MN-88-100/T	1,5-3		12	60	001244
MN-88-101/T	1,5-3		12	60	001251







index					5906757
	mm	m	pcs	pcs	
MN-05-136	38	33	1	48	272156
MN-05-138	50	33	1	36	272163



MASKING TAPES







index					5906675
	mm	m	pcs	pcs	
MN-05-140	25	25	6	72	013422
MN-05-142	38	25	6	48	013459
MN-05-144	48	25	6	36	013466



MASKING TAPES







index					5906757
	mm	m	pcs	pcs	
MN-05-232	38	25	6	48	000940
MN-05-234	50	25	6	36	000957
MN-05-236	38	10	6	48	000964
MN-05-238	50	10	6	36	000971



DOUBLE-SIDED STRENGTHENED TAPE







index					5906675
	mm	m	pcs	pcs	
MN-05-250	19	5	1	90	437194
MN-05-252	19	1,5	1	90	437200



DOUBLE-SIDED MOUNTING TAPE



index					5906757
	mm	m	pcs	pcs	
MN-05-330	48	10	6	48	267350
MN-05-332	48	25	6	48	268395
MN-05-334	48	50	6	24	910379



PACKING TAPES DUCT TAPE



PACKING TAPES DUCT TAPE



index	mm	m	pcs	pcs	5906757
MN-05-340	48	10	6	36	910362



UNIVERSAL PLASTERING TAPE



index	mm	m	pcs	pcs	5906675
MN-05-350	38	20	6	48	437132
MN-05-351	38	50	1	32	437149
MN-05-353	48	25	6	36	437170
MN-05-352	48	50	1	24	437163



WARNING TAPE



index	mm	m	pcs	pcs	5906757
MN-05-605	75	100	1	42	155046



INSULATION TAPE



MN-05-006 MN-05-008 MN-05-009 MN-05-010

index	mm	m	pcs	pcs	5906757
MN-05-006	15	10	10	100	159655
MN-05-008	19	20	8	96	070790
MN-05-009	19	20	8	96	001664
MN-05-010	19	20	8	96	001671



SELF-ADHESIVE PROTECTIVE FILM 45 µm



index	mm	m	pcs	pcs	5906757
MN-05-640	250	30	1	12	002043
MN-05-641	500	75	1	6	002050



index				5906757
	mm	pcs	pcs	
MN-79-100	160x100	1	20	086586

MASONRY HOOK FOR TRAVERSING



index		a x b			5906757
	mm	mm	pcs	pcs	
MN-79-161	300	22x16	1	6	903678
MN-79-162	450	30x16	1	6	903685
MN-79-163	600	30x16	1	6	903692
MN-79-164	750	30x16	1	6	903708
MN-79-165	900	30x16	1	6	903715



FORGED CROWBAR WITH NAIL-PULLER

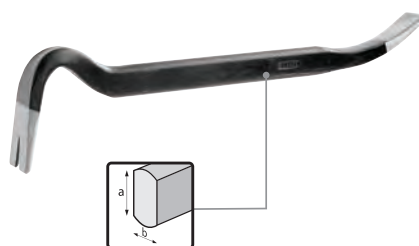

index				5906757
	mm	pcs	pcs	
MN-02-460	60	10	60	143586
MN-02-475	75	10	60	143593
MN-02-490	90	6	36	143609

BRASS BOLT PADLOCKS EXTRA LOCK



index				5906675
	m	pcs	pcs	
MN-79-355	1,1	1	6	023854



SQUARE SHOVEL FIBERGLASS



NEW

index				5906675
	m	pcs	pcs	
MN-79-356	1,1	1	6	023861



ROUND NOSE SHOEL FIBERGLASS





NEW

COAL SHOVEL FIBERGLASS



NEW



index				5906675
	m	pcs	pcs	
MN-79-357	1,1	1	6	23878



FOUR-PRONGED FORK FIBERGLASS



NEW



index				5906675
	m	pcs	pcs	
MN-79-358	1,1	1	6	023885



RAKE FORGED FIBREGLASS



NEW



index				5906675
	m	pcs	pcs	
MN-79-405	1,5	1	6	083179



RAKE FORGED FIBREGLASS



NEW



index				5906675
	m	pcs	pcs	
MN-79-406	1,5	1	6	083186





SQUARE SHOVEL



NEW

index				5906757
	m	pcs	pcs	
MN-79-360	1,15	1	6	904934





index				5906757
	m	pcs	pcs	
MN-79-365	1,15	1	6	904941



ROUND NOSE SHOEL



NEW



index				5906757
	m	pcs	pcs	
MN-79-370	1,15	1	6	904965



COAL SHOVEL



NEW



index				5906757
	m	pcs	pcs	
MN-79-375	1,5	1	6	904958



FOUR-PRONGED FORK





NEW

index	a	b	c			5906675
	mm	mm	mm	pcs	pcs	
MN-79-400	1230	200	295	1	6	083131

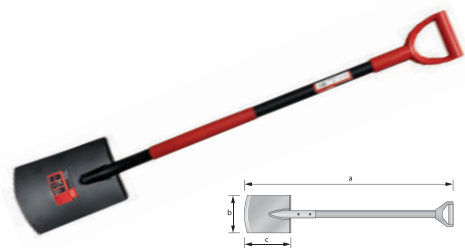

HARDENED SPADE



index	a	b	c			5906675
	mm	mm	mm	pcs	pcs	
MN-79-401	1230	200	295	1	6	083148

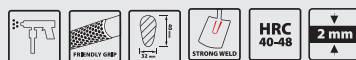

ROUND NOSE SHOEL

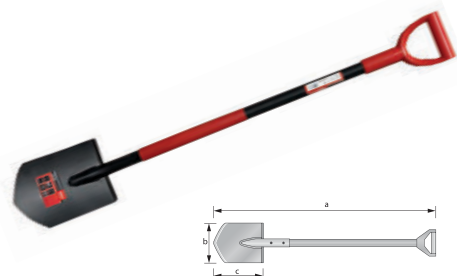

SAND SHOVEL

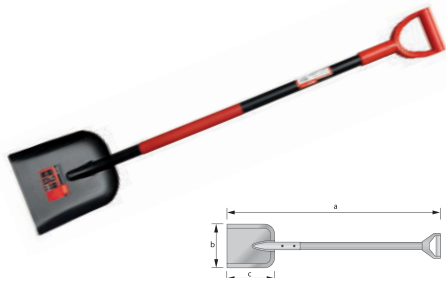

index	a	b	c			5906675
	mm	mm	mm	pcs	pcs	
MN-79-402	1230	245	295	1	6	083155



COAL SHOVEL

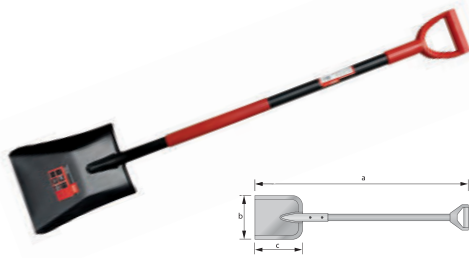

index	a	b	c			5906675
	mm	mm	mm	pcs	pcs	
MN-79-403	1230	245	295	1	6	083162



STREET BROOMERS WITH A HANDLE



index				5906757
	mm	pcs	pcs	
MN-71-802	400	1	10	905795
MN-71-803	500	1	10	905801
MN-71-804	600	1	10	905818



STREET BROOM STICK 1,3 M



index	L			5906757
	m	pcs	pcs	
MN-71-804-A	1,3	1	10	905825

GOATSKIN WORK GLOVES



index	size			5906757
		pcs	pcs	
MN-06-150/10	10"	12	12	909472
MN-06-150/9	9"	12	12	909465



index	size	pcs	pcs	5906757
MN-06-171/11	10,5"	12	12	909533



LINED COWHIDE GLOVES LUX



index	size	pcs	pcs	5906757
MN-06-164/9	9"	12	12	909762



LATEX-COVERED FLEXIBLE GLOVES



index	size	pcs	pcs	5906675
MN-06-210	10,5"	12	120	088259



WHITE COTTON RUBBER COATED GLOVES



index	size	pcs	pcs	5906675
MN-06-212	10"	12	240	088266
MN-06-212/9	9"	12	240	393834



RED POLYESTER WITH BLACK LATEX COATED GLOVES



index	size	pcs	pcs	5906675
MN-06-214	10"	12	240	088273
MN-06-214/9	9"	12	240	393841



GREY POLYESTER WITH GREY NITRILE COATED GLOVES



GREY SHELL WITH BLUE LATEX COATED GLOVES



index	size	pcs	pcs	5906675
MN-06-216	10"	12	120	088280
MN-06-216/9	9"	12	120	393858



BLUE POLYESTER WITH BLACK NITRIL COATED GLOVES



index	size	pcs	pcs	5906675
MN-06-218	10"	12	240	088297
MN-06-218/9	9"	12	240	393865



BLACK POLYESTER WITH BLACK POLYURETHAN COATED GLOVES



index	size	pcs	pcs	5906675
MN-06-220	10"	12	240	088303
MN-06-220/9	9"	12	240	393872



SAFETY HELMET



index	pcs	pcs	5906757
MN-06-145-1	1	40	001800



Material: ABS
 Protection: 1000V (AC), 1500V (DC)
 Reflective strips
 6 points textil harness
 Vents
 4 points chin strap



SAFETY HELMET



index	colour	pcs	pcs	5906757
MN-06-143-1	●	1	60	001947
MN-06-143-2	●	1	60	001763
MN-06-143-3	●	1	60	001770



Material: HDPE
 Weight 0,318kg
 Protection: 1000V (AC) 1500V (DC)
 The chin strap is an additional option:
 Four-point MN-06-140-2

index	colour	pcs	pcs	5906757
MN-06-144-1		1	56	001954
MN-06-144-2		1	56	001787
MN-06-144-3		1	56	001794



Material: HDPE

Weight 0,318kg

Protection: 1000V
(AC) 1500V (DC)

The chin strap is an additional option:
Four-point MN-06-140-2

index	pcs	pcs	5906757
MN-06-140-2	1	500	001824



matches
MN-06-143 and MN-06-144

index	pcs	pcs	5906757
MN-06-109	1	15	267428



SAFETY HELMET





4-POINT STRAP



FACE SHIELD OTP-1



index	Protection class		pcs	pcs	5906757
	pcs	colour			
MN-06-610/3	FFP1		3	300	67245
MN-06-611/3	FFP2		3	300	67252
MN-06-612/2	FFP3		2	300	67269



FILTERING HALF MASK WITH VALVE



NEW

Available - 08.2023

index	Protection class		pcs	pcs	5906757
	pcs	pcs			
MN-06-621/2	FFP2		2	300	67283



FILTERING HALF-MASK WITH VALVE AND ACTIVE CARBON





NEW

Available - 08.2023

Active carbon absorbs odours

PROTECTIVE EAR MUFFS 27 dB



index			5906757
	pcs	pcs	
MN-06-205	12	48	119604



SILICONE FILLED PROTECTIVE KNEE PADS



index			5906757
	pcs	pcs	
MN-06-303	6	12	904781



The Modeco Expert Multi Storage System is a perfect solution for all hand tool users.

Seeking to organise and protect your tools, so that they are also available for everyday repair work, you will surely appreciate the Multi Storage System of modular portable toolboxes from Modeco Expert. The system consists of 7 elements: 2 alternative transport systems – a wheeled box and a transport platform, a toolbox, a larger and a smaller open box, and two organisers.

To accommodate each user's unique needs, the system comprises boxes of 3 sizes and capacities of 14.3, 26, and 38 litres, allowing you to choose the right size to suit your individual preferences. But the greatest advantage of the MULTI STORAGE SYSTEM is that all boxes are fully compatible with one another, so you can stack them like bricks, one on top of the other, to build your customised set.

3 BOX CAPACITIES: 14.3, 26, and 38 l

REMOVABLE INNER COMPARTMENT SEPARATORS for easy space organisation

HIGH-PRECISION POLYAMIDE LID LATCHES without sharp edges

COMPATIBLE BOXES which can be stacked like bricks, one on top of the other, to build customised sets

2 ALTERNATIVE TRANSPORT SYSTEMS featuring a wheeled box and a transport platform

TOOL TRANSPORT ACCESSORIES

**MODULAR PORTABLE
TOOL BOX SYSTEM**
consisting of 7
components

**TELESCOPIC WHEELED
BOX HANDLE** for easy
transport and storage



TOOL BOX SYSTEM - ORGANISER 14,3 L



index	size mm	cap. l	pcs	pcs	5906675
MN-03-170	530x310x130	14,3	1	1	456409

polycarbonate transparent cover
9 removable small bins
reinforced ribbed construction
strong and durable side connectors
polyamide latches
14,3l capacity
handle lock in 90° position

TOOL BOX SYSTEM - TOOL BOX 26 L



index	size mm	cap. l	pcs	pcs	5906675
MN-03-171	530x313x223	26	1	1	456416

reinforced ribbed construction
strong and durable side connectors
polyamide latches
26 l capacity
handle lock in 90° position
2 removable dividers

TOOL BOX SYSTEM - WHEELED BOX 38 L



index	size mm	cap. l	pcs	pcs	5906675
MN-03-172	530x385x690	38	1	1	456423

reinforced ribbed construction
strong and durable side connectors
polyamide latches
38l capacity
handle lock in 90° position
2 removable dividers
telescopic handle

TOOL BOX SYSTEM - OPEN BOX 14,3 L



index	size mm	cap. l	pcs	pcs	5906675
MN-03-173	530x310x130	14,3	1	1	456430

reinforced ribbed construction
strong and durable side connectors
5 removable dividers
14,3l capacity

TOOL BOX SYSTEM - OPEN BOX 26 L



index	size mm	cap. l	pcs	pcs	5906675
MN-03-174	530x295x195	26	1	1	456447

reinforced ribbed construction
strong and durable side connectors
2 removable dividers
26l capacity

index	size			5906675
	mm	pcs	pcs	
MN-03-175	595x395x175	1	1	456454

reinforced ribbed construction
strong and durable side connectors
max. load capacity 100kg
4 wheels rotating 360°
2 wheels equipped with brakes

TOOL BOX SYSTEM - TRANSPORT PLATFORM



index	size			5906675
	mm	pcs	pcs	
MN-03-176	257x180x65	1	1	456461

polycarbonate transparent cover
6 removable dividers
fits into MN-03-171 (4 pcs.)
fits into MN-03-174 (6 pcs.)

TOOL BOX SYSTEM - SMALL ORGANISER



index						5906757
	mm	pcs	pcs	pcs	pcs	
MN-03-110	430x220x200	2	1	6	6	908536



TOOL BOX



index						5906757
	mm	pcs	pcs	pcs	pcs	
MN-03-112	510x255x235	2	1	4	4	908543



TOOL BOX



index				5906757
	mm	pcs	pcs	
MN-03-460	610x300x280	1	10	910287



TOOL BAG



TOOL BAG



index	①	📦	📦	5906757
	mm	pcs	pcs	
MN-03-464	460x280x300	1	10	910294



TOOL BAG



index	①	📦	📦	5906757
	mm	pcs	pcs	
MN-03-466	500x230x280	1	4	910300



LEATHER TOOL BELT



index	📦	📦	5906675
	pcs	pcs	
MN-03-218	5	30	377704



HAMMER HOLDER LEATHER



NEW

index	📦	📦	5906675
	pcs	pcs	
MN-03-219	1	50	509624





NAIL POCKET LEATHER



NEW

index	📦	📦	5906675
	pcs	pcs	
MN-03-220	1	50	509631



index			5906757
	pcs	pcs	
MN-03-401	6	72	273412

CLIP & BELT LOOP 80-140 CM



index			5906757
	pcs	pcs	
MN-03-406	6	72	273429

HAMMER HOLDER POUCH



index			5906757
	pcs	pcs	
MN-03-416	6	60	273443

DRILL POUCH



index			5906757
	pcs	pcs	
MN-03-421	6	60	273450

NAIL POUCHES



index			5906757
	pcs	pcs	
MN-03-422	6	60	273467

NAIL POUCHES



UNIVERSAL TOOL APRON



index			5906757
	pcs	pcs	
MN-03-426	6	60	273474



UNIVERSAL TOOL APRON





index			5906757
	pcs	pcs	
MN-03-427	6	60	273481



PLASTERBOARD INSTALLER TOOL BELT





index				5906757
	pieces	pcs	pcs	
MN-03-451	4	1	6	274839



				
	pcs		pcs	pcs
	1		1	
			1	

ROOFER'S TOOL BELT



index				5906757
	pieces	pcs	pcs	
MN-03-452	3	1	6	274846



				
	pcs		pcs	pcs
	1		1	



MODECO
EXPERT

5m x 19mm

5m

CUTTING TOOLS

Some of the most typical activities performed in workshops and on construction sites are wood working as well as cutting of metal, aerated concrete, plasterboard, and wood-based materials

Because of such a wide range of applications, one should always rely on cutting tools whose high quality is guaranteed by the manufacturer. And this is precisely the case of the Modeco Expert cutting tools. The Modeco Expert portfolio includes knives, shears, cold chisels, saws, thread cutters, and wood chisels. They are safe and comfortable to use, and made of solid materials such as stainless steel and tool steel.

The Modeco Expert knives can be used in both household and professional work-shops. They differ not only in construction, but also in the blade type, which directly affects their application and handling. Our offering includes aluminium and two-component knives with trapezoidal, trapezoidal-hook, and broken blades.

Some tougher materials, such as metal sheets and steel sections, can be successfully worked using the Modeco Expert shears, which are divided into left- and right-handed, depending on the blade geometry. Thanks to their articulated design, less force is required during cutting, which makes the work easier.





**UTILITY KNIFE WITH DETACHABLE SEGMENTED
BLADE 9MM**



index				5906757
	mm	pcs	pcs	
MN-63-011	9	12	240	269187



**UTILITY KNIFE WITH DETACHABLE SEGMENTED
BLADE 18MM**



index				5906757
	mm	pcs	pcs	
MN-63-021	18	12	96	269194



**UTILITY KNIFE WITH DETACHABLE SEGMENTED
BLADE 18MM**



index				5906757
	mm	pcs	pcs	
MN-63-025	18	12	120	265868



**UTILITY KNIFE WITH DETACHABLE SEGMENTED
BLADE 18MM**



index				5906675
	mm	pcs	pcs	
MN-63-026	18	6	144	038209





**UTILITY KNIFE WITH DETACHABLE TRAPEZOID
BLADE**



index				5906757
	mm	pcs	pcs	
MN-63-034	19x61	12	48	267381





index				5906675
	mm	pcs	pcs	
MN-63-040	19x61	6	72	038186



ALU KNIFE WITH DETACHABLE TRAPEZOID BLADE





CUTTING TOOLS

index				5906675
	mm	pcs	pcs	
MN-63-042	19x61	6	72	038193



UTILITY KNIFE WITH DETACHABLE TRAPEZOID BLADE





index				5906675
	mm	pcs	pcs	
MN-63-039	19x50	6	72	038230



ALU KNIFE WITH DETACHABLE TRAPEZOID BLADE







index				5906757
	mm	pcs	pcs	
MN-63-041	25	12	120	269156



UTILITY KNIFE WITH DETACHABLE SEGMENTED BLADE 25 MM



in1					5906757
	mm	pcs	pcs	pcs	
MN-63-121	9	10	12	360	268876

SEGMENTED BLADES 9 MM GOLD LINE



SEGMENTED BLADES 18MM GOLD LINE



index					5906757
	mm	pcs	pcs	pcs	
MN-63-124	18	10	12	288	268883
MN-63-125	18	10	50	300	268890
MN-63-126	18	50	12	72	268975

TRAPEZOID BLADES GOLD LINE



index					5906757
	mm	pcs	pcs	pcs	
MN-63-127	19x61	10	12	240	268906

TRAPEZOID HOOK BLADE GOLD LINE



index					5906757
	mm	pcs	pcs	pcs	
MN-63-130	19x50	10	12	240	268920
MN-63-131	19x50	10	1	300	268944

SEGMENTED HOOK BLADES 18 MM



index					5906757
	mm	pcs	pcs	pcs	
MN-63-133	18	10	12	288	268937





SEGMENTED BLADES 25MM GOLD LINE





index					5906757
	mm	pcs	pcs	pcs	
MN-63-137	25	10	12	120	268968



index				5906757
	mm	pcs	pcs	
MN-63-327	190	12	120	246317
MN-63-328	210	12	120	246324
MN-63-329	240	12	120	246331

OFFICE SCISSORS





index	d	h			5906757
	mm	mm	pcs	pcs	
MN-63-067	280	420	10	60	909069

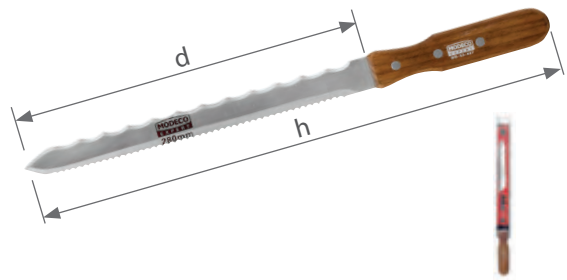

MINERAL WOOL KNIFE



index	d	h			5906675
	mm	mm	pcs	pcs	
MN-63-069	340	480	10	60	377773

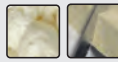

MINERAL WOOL KNIFE

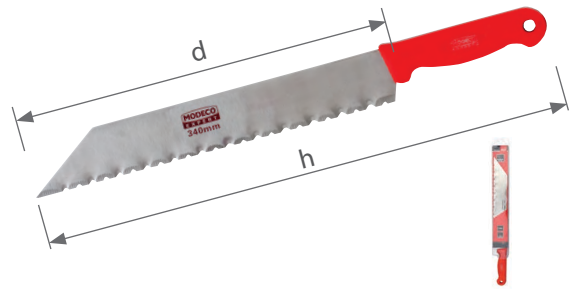

SHEARS

Our flagship product in the family of cutting tools, designed for cutting of metal sheets, steel profiles, metal roofing tiles, etc., is the 250mm long sheet metal shears made of chromium-molybdenum steel.

These are typically used by roofers, electricians, plumbers, and fitters. Their distinguishing feature is the articulated construction which makes cutting easier and requires less force. The automatic jaw lock secures the shears during transport and allows one-handed opening. The two-piece handle improves grip ergonomics and increases comfort of use.





▶ **FORGED JAW MADE OF CRO-MO STEEL WITH HARDNESS OF 56-62 HRC** ensuring extended service life and making it possible to cut sheet metal up to 1.8mm in thickness

▶ **AUTOMATIC JAW LOCK** securing the shears during transport and allowing one-handed opening

PROFILED JAW ◀ enabling perfect cutting in a straight line and to the left

ARTICULATED DESIGN ◀ for easier cutting (less force required)



ERGONOMICALLY PROFILED TWO-COMPONENT HANDLE ◀ for improved comfort of use

index					8590718
	mm	mm	pcs	pcs	
MN-63-214	250	1,8	6	48	730518



JOINT SHEARS FOR METAL SHEET - STRAIGHT SPARTAN





index					8590718
	mm	mm	pcs	pcs	
MN-63-215	250	1,8	6	48	730532



JOINT SHEARS FOR METAL SHEET - LEFT SPARTAN





index					8590718
	mm	mm	pcs	pcs	
MN-63-216	250	1,8	6	48	160124



JOINT SHEARS FOR METAL SHEET - RIGHT SPARTAN



index					5906757
	mm	mm	pcs	pcs	
MN-63-201	250	1,2	6	36	151673



JOINT SHEARS FOR METAL SHEET - RIGHT SPARTAN



index					5906757
	mm	mm	pcs	pcs	
MN-63-202	250	1,2	6	36	151680



JOINT SHEARS FOR METAL SHEET - LEFT

JOINT SHEARS FOR METAL SHEET - LEFT
НОЖНИЦЫ С ШАРНИРОМ ПО МЕТАЛЛУ ЛЕВОСТОРОННИЕ



JOINT SHEARS FOR METAL SHEET - STRAIGHT



index					5906757
	mm	mm	pcs	pcs	
MN-63-203	250	1,2	6	36	151697



JOINT SHEARS FOR METAL SHEET - RIGHT



index					5906757
	mm	mm	pcs	pcs	
MN-63-211	250	1,2	6	36	121034



JOINT SHEARS FOR METAL SHEET - LEFT



index					5906757
	mm	mm	pcs	pcs	
MN-63-212	250	1,2	6	36	121041



JOINT SHEARS FOR METAL SHEET



index					5906757
	mm	mm	pcs	pcs	
MN-63-213	250	1,2	6	36	126664





JOINT SHEARS FOR METAL SHEET - STRAIGHT



index					5906757
	mm	mm	pcs	pcs	
MN-63-210	290	1,2	6	36	268562







index				5906757
	mm	pcs	pcs	
MN-63-181	175	6	36	268531
MN-63-182	250	6	36	268548



SHEARS FOR METAL SHEET CLASSIC



index					5906757
	mm	mm	pcs	pcs	
MN-63-185	250	1,2	3	30	270015



SHEARS FOR METAL SHEET - RIGHT CLASSIC



index					5906757
	mm	mm	pcs	pcs	
MN-63-186	250	1,2	3	30	270022



SHEARS FOR METAL SHEET - STRAIGHT CLASSIC







index					5906757
	mm	mm	pcs	pcs	
MN-63-187	300	1,4	3	30	270039



SHEARS FOR METAL SHEET CLASSIC



index					5906757
	mm	mm	pcs	pcs	
MN-63-249	200	3	6	24	161818
MN-63-219	450	6	6	12	146648
MN-63-225	600	8	1	12	146655
MN-63-231	750	10	1	6	146662
MN-63-237	900	12	1	4	157897



Cr-Mo

WIRE SHEARS



RIPPING CHISEL





index				5906757
	mm	pcs	pcs	
MN-67-060	10	6	120	908161
MN-67-062	12	6	60	908178
MN-67-064	14	6	60	908185
MN-67-066	16	6	120	908192
MN-67-068	18	6	60	908208
MN-67-070	20	6	60	908215
MN-67-072	22	6	60	908222
MN-67-075	25	6	60	908239
MN-67-080	30	6	120	908246
MN-67-082	32	6	60	908253







RASP WITH ALUMINIUM BODY



index				5906757
	mm	pcs	pcs	
MN-66-722	250x40	1	18	271401

COLD CHISEL WITH GUARD







index					5906757
	mm	mm	pcs	pcs	
MN-63-481	250	27	6	36	908581
MN-63-482	300	27	6	36	908598
MN-63-484	350	27	6	24	908611



COLD CHISEL WITH GUARD





index					5906757
	mm	mm	pcs	pcs	
MN-63-487	215	100	6	24	908635



PVC TUBE SHEARS



index				5906675
	mm	pcs	pcs	
MN-62-551	3-42	6	48	393704
MN-62-552	3-42	6	36	393711





index	①	📦 pcs	📦 pcs	5906757
MN-62-034	M4	1	50	078789
MN-62-035	M5	1	50	078796
MN-62-036	M6	1	50	078802
MN-62-038	M8	1	25	078819
MN-62-040	M10	1	25	078826
MN-62-042	M12	1	25	078833
MN-62-044	M14	1	20	085053
MN-62-046	M16	1	20	079403
MN-62-050	M20	1	20	096806

SCREW TAPS



index	①	📏 mm	📦 pcs	📦 pcs	5906757
MN-62-060	M4-M8	200	1	10	139619
MN-62-061	M9-M12	290	1	10	139626
MN-62-062	M13-M18	440	1	10	139633

TAP WRENCHES



index	①	📦 pcs	📦 pcs	5906757
MN-62-136	M6	1	50	079816
MN-62-138	M8	1	30	079823
MN-62-140	M10	1	30	079830
MN-62-142	M12	1	30	079847
MN-62-144	M14	1	25	085671
MN-62-146	M16	1	25	079854
MN-62-150	M20	1	25	110670

DIE NUT



index	①	📏 mm	📦 pcs	📦 pcs	5906757
MN-62-161	20x7 M4-M6	190	1	10	139671
MN-62-162	25x9 M8	230	1	10	139688
MN-62-163	30x11 M10	255	1	10	139695
MN-62-164	38x14 M12-M14	305	1	10	139701
MN-62-165	45x16 M16	380	1	10	110366

DIE NUT HOLDER



index	①	📦 pieces	📦 pcs	📦 pcs	5906757
MN-62-304		31	1	5	079397

SET OF SCREWTAPERS AND DIE NUTS M3-M12, 31 PCS

①	mm
	M3, M4 M5, M6, M8, M10, M12
	L=120 mm L=310 mm
	M3, M4, M5, M6, M8, M10, M12
	L=215 mm L=325 mm



SET OF SCREWTAPERS M3-M12 25 PCS



index	① pieces	📦 pcs	📦 pcs	5906757
MN-62-308	25	1	60	087682

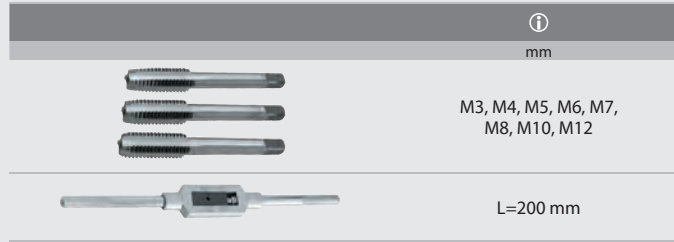

METAL HAND SAW 300 MM



index	↔ mm	📦 pcs	📦 pcs	5906757
MN-65-006	300	6	36	140134



METAL HAND SAW 300MM



index	↔ mm	📦 pcs	📦 pcs	5906757
MN-65-010	300	6	36	140127



METAL HAND SAW 300 MM





index	↔ mm	📦 pcs	📦 pcs	5906757
MN-65-013	300	6	36	908826



WOLFRAM BLADES – ROUND







index	↔ mm	📦 pcs	📦 pcs	5906757
MN-65-143	300	1	100	245600

index				5906757
	mm	pcs	pcs	
MN-65-131	300x25	72	720	109940

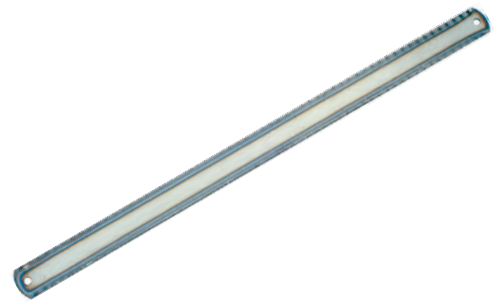

DOUBLE-EDGED BLADE 300X25 MM





index				5906757
	mm	pcs	pcs	
MN-65-135	300x25	72	720	110779

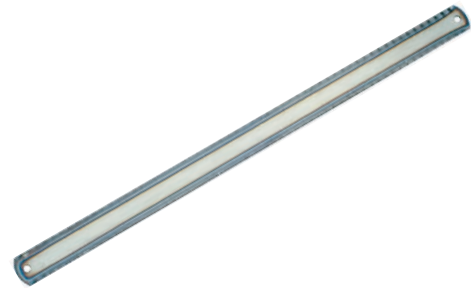

DOUBLE-EDGED BLADE 300X25 MM



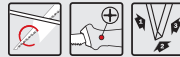

index				5906757
	mm	pcs	pcs	
MN-65-207	155	12	48	271029



hardened 8/1"
teeth, thickness 1,5mm,
for cutting plasterboards,
wood and PVC

DRYWALL SAW 155 MM





index				5906757
	mm	pcs	pcs	
MN-65-208	300	6	36	903562



for cutting wood,
plasterboards and PVC

HAND SAW 300 MM



index				5906757
	mm	pcs	pcs	
MN-65-511	550	6	24	902596





hardened teeth teflon
coating, for cutting wood,
PVC and plasterboards

DRYWALL SAW 550 MM



TENON SAW 300 MM





index				5906757
	mm	pcs	pcs	
MN-65-413	300	6	24	266537



hardened 14/1" teeth,
for cutting wood,
plywood and panels

HAND SAWS GOLD LINE





index				5906757
	mm	pcs	pcs	
MN-65-522	400	6	24	270053
MN-65-523	450	6	24	270060
MN-65-524	500	6	24	270077
MN-65-525	550	6	24	270084



hardened 9/1" teeth
FRIENDLY GRIP
thickness 1mm, for
cutting wood, plywood
and panels

ONE-SIDED NARROW BLADE





index				5906757
	mm	pcs	pcs	
MN-65-526	400	10	60	157262
MN-65-528	450	10	60	157279
MN-65-530	500	10	60	157286



hardened 9/1" teeth
thickness 1mm, for
cutting wood, plywood
and panels. screw fixed
blade

HAND SAWS BLACK SHARK







index				5906757
	mm	pcs	pcs	
MN-65-542	400	10	60	908833
MN-65-543	450	10	60	908840
MN-65-544	500	10	60	908857



hardened 8/1" teeth
FRIENDLY GRIP
thickness 1 mm, for cutting
wood, plywood and panels



CELLULAR CONCRETE SAW 700 MM GOLD LINE



index					5906757
	mm	widias/teeth	pcs	pcs	
MN-65-640	700	17/34	6	12	273139



HM teeth, FRIENDLY GRIP,
for cutting hollow tiles
and ceramics

index				5906757
	mm	pcs	pcs	
MN-65-220	530	12	24	265721
MN-65-224	600	1	12	265745
MN-65-230	760	1	12	265752





FRAME SAWS



NEW



CUTTING TOOLS



index				5906757
	mm	pcs	pcs	
MN-65-250	530	20	200	265776
MN-65-254	600	20	200	265783
MN-65-260	760	20	200	265790

FRAME SAW BLADES



NEW



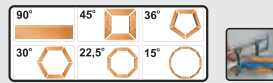

index				5906757
	mm	pcs	pcs	
MN-65-550	550	1	3	099852

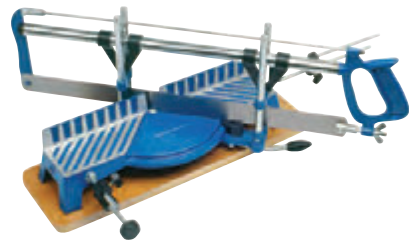

ANGLED CUTTING TOOL



aluminium body

index	rows			5906757
		pcs	pcs	
MN-69-013	3	10	10	150867
MN-69-014	4	10	10	150874
MN-69-015	5	10	10	150881
MN-69-016	6	10	10	154810



WIRE BRUSHES



LIST OF INDEXES

Index	Page	Index	Page	Index	Page	Index	Page	Index	Page	Index	Page
MN-02-460	159	MN-05-136	157	MN-09-096	126	MN-15-412	50	MN-20-165	96	MN-26-016	97
MN-02-475	159	MN-05-138	157	MN-10-107	83	MN-15-501	51	MN-20-180	92	MN-26-017	97
MN-02-490	159	MN-05-140	157	MN-10-151	82	MN-15-502	51	MN-20-184	92	MN-26-018	97
MN-02-503	125	MN-05-142	157	MN-10-152	82	MN-15-511	51	MN-20-187	93	MN-26-020	91
MN-02-506	125	MN-05-144	157	MN-10-153	82	MN-15-512	51	MN-20-189	93	MN-26-023	91
MN-02-508	125	MN-05-232	157	MN-10-154	82	MN-15-514	52	MN-20-191	93	MN-26-025	92
MN-02-510	125	MN-05-234	157	MN-10-157	82	MN-15-515	52	MN-20-192	93	MN-26-027	92
MN-02-512	125	MN-05-236	157	MN-10-159	82	MN-15-521	52	MN-20-205	96	MN-26-066	97
MN-02-612	125	MN-05-238	157	MN-10-160	82	MN-15-522	52	MN-20-226	94	MN-26-067	97
MN-02-613	125	MN-05-250	157	MN-10-161	82	MN-15-540	53	MN-20-265	96	MN-26-077	97
MN-02-615	125	MN-05-252	157	MN-10-162	82	MN-15-541	53	MN-20-305	96	MN-26-120	98
MN-02-621	125	MN-05-330	157	MN-10-163	82	MN-15-542	53	MN-20-326	94	MN-26-121	98
MN-02-622	125	MN-05-332	157	MN-10-165	82	MN-16-006B	54	MN-20-505	96	MN-26-122	98
MN-02-623	125	MN-05-334	157	MN-10-168	82	MN-16-007	53	MN-20-526	94	MN-26-123	98
MN-02-624	125	MN-05-340	158	MN-10-171	82	MN-16-008	53	MN-20-607	97	MN-26-140	98
MN-02-626	125	MN-05-350	158	MN-10-172	82	MN-16-008B	54	MN-20-610	97	MN-26-141	98
MN-02-632	125	MN-05-351	158	MN-10-173	82	MN-16-010	53	MN-20-612	97	MN-26-142	98
MN-02-633	125	MN-05-352	158	MN-10-175	82	MN-16-010B	54	MN-20-620	94	MN-26-218	98
MN-02-634	125	MN-05-353	158	MN-10-200	83	MN-16-013	53	MN-20-650	90	MN-30-402	103
MN-02-635	125	MN-05-605	158	MN-10-551	86	MN-16-013B	54	MN-20-706	94	MN-30-403	103
MN-02-636	125	MN-05-640	158	MN-10-552	86	MN-16-105	54	MN-20-708	94	MN-30-404	103
MN-02-643	125	MN-05-641	158	MN-10-553	86	MN-16-205	54	MN-20-710	94	MN-30-405	103
MN-02-644	125	MN-06-109	165	MN-10-554	86	MN-16-207	54	MN-20-716	95	MN-30-408	103
MN-02-645	125	MN-06-140-2	165	MN-10-561	86	MN-16-208	54	MN-20-718	95	MN-30-410	103
MN-02-646	125	MN-06-143-1	164	MN-10-562	86	MN-16-215	55	MN-20-720	95	MN-30-415	103
MN-03-110	169	MN-06-143-2	164	MN-10-563	86	MN-17-050	87	MN-20-726	95	MN-30-420	103
MN-03-112	169	MN-06-143-3	164	MN-10-570	86	MN-17-140	87	MN-20-728	95	MN-30-603	103
MN-03-170	168	MN-06-144-1	165	MN-10-571	86	MN-17-190	87	MN-20-730	95	MN-30-605	103
MN-03-171	168	MN-06-144-2	165	MN-10-572	86	MN-17-200	87	MN-20-736	95	MN-30-608	103
MN-03-172	168	MN-06-144-3	165	MN-10-573	86	MN-17-240	87	MN-20-738	95	MN-30-610	103
MN-03-173	168	MN-06-145-1	164	MN-10-580	86	MN-17-240/1	87	MN-20-740	95	MN-30-615	103
MN-03-174	168	MN-06-150/10	162	MN-10-581	86	MN-17-290	87	MN-22-008	98	MN-30-620	103
MN-03-175	169	MN-06-150/9	162	MN-10-582	86	MN-17-290/1	87	MN-22-011	98	MN-31-212	104
MN-03-176	169	MN-06-164/9	163	MN-11-070	86	MN-19-010	54	MN-22-012	98	MN-31-216	104
MN-03-218	170	MN-06-171/11	163	MN-11-081	82	MN-20-005	95	MN-22-014	99	MN-31-224	104
MN-03-219	170	MN-06-205	166	MN-11-082	82	MN-20-026	93	MN-22-018	99	MN-31-232	104
MN-03-220	170	MN-06-210	163	MN-13-004	83	MN-20-027	93	MN-23-057	89	MN-32-001	102
MN-03-401	171	MN-06-212	163	MN-13-007	83	MN-20-028	93	MN-23-060	90	MN-32-007	102
MN-03-406	171	MN-06-212/9	163	MN-13-009	83	MN-20-080	88	MN-23-062	90	MN-32-008	102
MN-03-416	171	MN-06-214	163	MN-13-014	83	MN-20-081	88	MN-23-064	90	MN-32-012	103
MN-03-421	171	MN-06-214/9	163	MN-13-017	83	MN-20-082	88	MN-23-066	91	MN-32-013	102
MN-03-422	171	MN-06-216	164	MN-14-205	84	MN-20-086	89	MN-23-068	91	MN-32-017	103
MN-03-426	172	MN-06-216/9	164	MN-14-206	84	MN-20-087	89	MN-23-079	91	MN-32-018	102
MN-03-427	172	MN-06-218	164	MN-14-207	84	MN-20-088	89	MN-25-101	99	MN-32-022	103
MN-03-451	172	MN-06-218/9	164	MN-14-210	88	MN-20-089	89	MN-25-102	99	MN-32-103	104
MN-03-452	172	MN-06-220	164	MN-15-152	52	MN-20-092	88	MN-25-103	99	MN-33-005	104
MN-03-460	26	MN-06-220/9	164	MN-15-152-2	53	MN-20-094	89	MN-25-110	99	MN-35-214	105
MN-03-460	169	MN-06-303	166	MN-15-302	50	MN-20-096	89	MN-25-111	99	MN-35-215	105
MN-03-464	26	MN-06-610/3	165	MN-15-312	50	MN-20-098	88	MN-25-112	99	MN-35-216	105
MN-03-464	170	MN-06-611/3	165	MN-15-391	50	MN-20-100	92	MN-25-113	99	MN-37-200	105
MN-03-466	26	MN-06-612/2	165	MN-15-393	51	MN-20-105	95	MN-25-115	99	MN-37-201	105
MN-03-466	170	MN-06-621/2	165	MN-15-394	51	MN-20-126	93	MN-25-410	99	MN-37-230	105
MN-05-006	158	MN-09-080	125	MN-15-395	51	MN-20-127	93	MN-25-412	99	MN-37-243	105
MN-05-008	158	MN-09-083	126	MN-15-396	51	MN-20-146	97	MN-25-414	99	MN-37-245	105
MN-05-009	158	MN-09-092	126	MN-15-398	51	MN-20-147	97	MN-25-418	99	MN-37-248	105
MN-05-010	158	MN-09-095	126	MN-15-402	50	MN-20-158	88	MN-25-424	99	MN-37-250	105

Index	Page	Index	Page	Index	Page	Index	Page	Index	Page	Index	Page
MN-37-255	105	MN-51-409	116	MN-59-616	117	MN-61-145	61	MN-61-628	59	MN-61-960	63
MN-37-260	105	MN-51-410	116	MN-59-617	117	MN-61-147	61	MN-61-630	59	MN-61-961	63
MN-37-262	105	MN-51-411	116	MN-59-618	117	MN-61-148	61	MN-61-632	59	MN-61-962	63
MN-37-263	105	MN-51-412	116	MN-59-619	117	MN-61-152	61	MN-61-635	59	MN-61-963	63
MN-37-264	105	MN-51-413	116	MN-59-657	118	MN-61-153	61	MN-61-640	59	MN-61-964	63
MN-37-265	105	MN-51-414	116	MN-59-710	117	MN-61-154	62	MN-61-678	60	MN-61-965	63
MN-37-266	105	MN-51-415	116	MN-59-713	117	MN-61-155	62	MN-61-680	60	MN-61-966	63
MN-37-270	105	MN-51-416	116	MN-59-717	117	MN-61-157	62	MN-61-753	60	MN-61-967	63
MN-37-353	105	MN-51-417	116	MN-59-719	117	MN-61-158	62	MN-61-756	60	MN-61-968	63
MN-37-354	105	MN-51-418	116	MN-59-757	118	MN-61-163	62	MN-61-760	60	MN-61-969	63
MN-37-356	105	MN-51-419	116	MN-60-230	57	MN-61-165	62	MN-61-801	59	MN-62-034	185
MN-37-359	105	MN-51-421	116	MN-60-240	57	MN-61-167	62	MN-61-802	59	MN-62-035	185
MN-40-006	110	MN-51-422	116	MN-60-250	57	MN-61-168	62	MN-61-902	63	MN-62-036	185
MN-40-007	110	MN-51-424	116	MN-60-260	57	MN-61-175	62	MN-61-903	63	MN-62-038	185
MN-40-008	110	MN-51-427	116	MN-60-265	57	MN-61-177	62	MN-61-904	63	MN-62-040	185
MN-40-017	110	MN-51-430	116	MN-60-270	57	MN-61-178	62	MN-61-905	63	MN-62-042	185
MN-40-018	110	MN-51-432	116	MN-60-280	57	MN-61-187	62	MN-61-906	63	MN-62-044	185
MN-40-020	111	MN-53-106	122	MN-60-300	57	MN-61-197	62	MN-61-907	63	MN-62-046	185
MN-40-023	111	MN-53-108	122	MN-60-310	57	MN-61-202	62	MN-61-908	63	MN-62-050	185
MN-40-025	111	MN-53-110	122	MN-60-320	57	MN-61-204	60	MN-61-909	63	MN-62-060	185
MN-40-110	111	MN-53-112	122	MN-60-904	57	MN-61-205	60	MN-61-910	63	MN-62-061	185
MN-40-305	111	MN-54-102	123	MN-60-906	57	MN-61-206	60	MN-61-911	63	MN-62-062	185
MN-40-310	111	MN-54-106	124	MN-60-911	57	MN-61-208	60	MN-61-912	63	MN-62-136	185
MN-45-100	109	MN-54-116	124	MN-60-931	57	MN-61-210	60	MN-61-913	63	MN-62-138	185
MN-45-109	109	MN-54-117	123	MN-60-932	58	MN-61-212	60	MN-61-914	63	MN-62-140	185
MN-45-110	109	MN-54-118	123	MN-60-933	58	MN-61-240	64	MN-61-915	63	MN-62-142	185
MN-45-120	109	MN-54-119	123	MN-60-934	58	MN-61-241	64	MN-61-916	63	MN-62-144	185
MN-46-106	109	MN-54-120	124	MN-61-054	61	MN-61-246	64	MN-61-917	63	MN-62-146	185
MN-46-108	109	MN-54-121	123	MN-61-056	61	MN-61-266	65	MN-61-918	63	MN-62-150	185
MN-46-110	109	MN-54-131	124	MN-61-057	61	MN-61-281	65	MN-61-919	63	MN-62-161	185
MN-46-112	109	MN-54-132	124	MN-61-064	61	MN-61-366	65	MN-61-920	63	MN-62-162	185
MN-46-114	109	MN-54-134	125	MN-61-065	61	MN-61-381	65	MN-61-921	63	MN-62-163	185
MN-46-146	109	MN-55-507	119	MN-61-070	61	MN-61-395	66	MN-61-922	63	MN-62-164	185
MN-46-148	109	MN-55-517	119	MN-61-071	61	MN-61-406	66	MN-61-923	63	MN-62-165	185
MN-46-150	109	MN-55-519	119	MN-61-076	61	MN-61-408	66	MN-61-924	63	MN-62-304	185
MN-46-152	109	MN-55-520	119	MN-61-077	61	MN-61-411	66	MN-61-925	63	MN-62-308	186
MN-46-154	109	MN-55-551	118	MN-61-091	62	MN-61-413	66	MN-61-926	63	MN-62-390	55
MN-50-236	115	MN-55-552	118	MN-61-092	62	MN-61-417	66	MN-61-927	63	MN-62-551	184
MN-50-238	115	MN-55-555	119	MN-61-093	62	MN-61-420	66	MN-61-928	63	MN-62-552	184
MN-50-240	115	MN-55-557	118	MN-61-094	62	MN-61-423	66	MN-61-929	63	MN-63-011	176
MN-50-413	115	MN-56-010	119	MN-61-106	61	MN-61-427	66	MN-61-930	63	MN-63-021	176
MN-50-422	115	MN-57-151	120	MN-61-109	61	MN-61-434	66	MN-61-931	63	MN-63-025	176
MN-50-428	115	MN-57-152	120	MN-61-116	61	MN-61-452	66	MN-61-932	63	MN-63-026	176
MN-50-440	115	MN-57-153	120	MN-61-117	61	MN-61-454	66	MN-61-933	63	MN-63-034	176
MN-50-449	115	MN-57-154	120	MN-61-121	61	MN-61-504	59	MN-61-934	63	MN-63-039	177
MN-50-453	115	MN-57-318	121	MN-61-122	61	MN-61-505	59	MN-61-937	63	MN-63-040	177
MN-50-456	115	MN-57-320	121	MN-61-123	61	MN-61-506	59	MN-61-938	63	MN-63-041	177
MN-50-458	115	MN-57-323	122	MN-61-124	61	MN-61-508	59	MN-61-950	63	MN-63-042	177
MN-50-462	115	MN-59-001	122	MN-61-131	61	MN-61-510	59	MN-61-951	63	MN-63-055	90
MN-51-236	116	MN-59-608	117	MN-61-132	61	MN-61-512	59	MN-61-952	63	MN-63-056	90
MN-51-238	116	MN-59-609	117	MN-61-133	61	MN-61-571	59	MN-61-953	63	MN-63-067	179
MN-51-242	116	MN-59-610	117	MN-61-134	61	MN-61-572	59	MN-61-954	63	MN-63-069	179
MN-51-250	117	MN-59-611	117	MN-61-137	61	MN-61-616	59	MN-61-955	63	MN-63-121	177
MN-51-255	117	MN-59-612	117	MN-61-141	61	MN-61-618	59	MN-61-956	63	MN-63-124	178
MN-51-406	116	MN-59-613	117	MN-61-142	61	MN-61-620	59	MN-61-957	63	MN-63-125	178
MN-51-407	116	MN-59-614	117	MN-61-143	61	MN-61-622	59	MN-61-958	63	MN-63-126	178
MN-51-408	116	MN-59-615	117	MN-61-144	61	MN-61-625	59	MN-61-959	63	MN-63-127	178

LIST OF INDEXES

Index	Page	Index	Page	Index	Page	Index	Page	Index	Page	Index	Page
MN-63-130	178	MN-65-182	67	MN-68-462/5	70	MN-68-823	73	MN-70-508	139	MN-72-542	143
MN-63-131	178	MN-65-183	67	MN-68-463/5	70	MN-68-824	73	MN-70-510	139	MN-72-544	143
MN-63-133	178	MN-65-184	67	MN-68-464/5	70	MN-68-825	73	MN-70-512	139	MN-72-546	143
MN-63-137	178	MN-65-185	67	MN-68-465/5	70	MN-68-831	73	MN-70-515	139	MN-72-548	143
MN-63-181	183	MN-65-186	68	MN-68-466/5	70	MN-68-832	73	MN-70-520	139	MN-72-550	143
MN-63-182	183	MN-65-187	68	MN-68-467/5	70	MN-68-833	73	MN-70-536	139	MN-72-580	143
MN-63-185	183	MN-65-188	68	MN-68-468/5	70	MN-68-834	73	MN-70-538	139	MN-72-581	143
MN-63-186	183	MN-65-189	68	MN-68-469/5	70	MN-68-835	73	MN-70-540	139	MN-73-040	140
MN-63-187	183	MN-65-190	68	MN-68-470	70	MN-68-841	73	MN-70-542	139	MN-73-041	140
MN-63-201	181	MN-65-191	68	MN-68-470/5	70	MN-68-842	73	MN-70-545	139	MN-73-042	140
MN-63-202	181	MN-65-192	68	MN-68-473	70	MN-68-843	73	MN-70-550	139	MN-73-043	140
MN-63-203	182	MN-65-193	68	MN-68-473/5	70	MN-68-844	73	MN-70-556	139	MN-73-044	140
MN-63-210	182	MN-65-194	68	MN-68-476	70	MN-68-845	73	MN-70-558	139	MN-73-045	140
MN-63-211	182	MN-65-195	68	MN-68-476/5	70	MN-68-902	72	MN-70-560	139	MN-73-046	140
MN-63-212	182	MN-65-196	68	MN-68-479	70	MN-68-905	72	MN-70-562	139	MN-73-047	140
MN-63-213	182	MN-65-197	68	MN-68-479/5	70	MN-68-907	72	MN-70-565	139	MN-73-050	141
MN-63-214	181	MN-65-198	68	MN-68-482	70	MN-68-908	72	MN-70-570	139	MN-73-051	141
MN-63-215	181	MN-65-199	68	MN-68-482/5	70	MN-68-909	72	MN-71-122	139	MN-73-052	141
MN-63-216	181	MN-65-200	68	MN-68-485	70	MN-68-911	72	MN-71-127	139	MN-73-053	141
MN-63-219	183	MN-65-201	68	MN-68-488	70	MN-68-912	72	MN-71-130	139	MN-73-054	141
MN-63-225	183	MN-65-207	187	MN-68-488/5	70	MN-68-915	72	MN-71-223	140	MN-73-055	141
MN-63-231	183	MN-65-208	187	MN-68-491	70	MN-68-916	72	MN-71-227	140	MN-73-060	141
MN-63-237	183	MN-65-220	189	MN-68-540/5	69	MN-68-917	72	MN-71-232	140	MN-73-061	141
MN-63-249	183	MN-65-224	189	MN-68-541/5	69	MN-68-922	73	MN-71-317	140	MN-73-062	141
MN-63-327	179	MN-65-230	189	MN-68-542/5	69	MN-68-925	73	MN-71-322	140	MN-73-063	141
MN-63-328	179	MN-65-250	189	MN-68-543/5	69	MN-68-931	73	MN-71-327	140	MN-73-064	141
MN-63-329	179	MN-65-254	189	MN-68-544/5	69	MN-68-932	73	MN-71-802	162	MN-73-065	141
MN-63-481	184	MN-65-260	189	MN-68-545/5	69	MN-68-935	73	MN-71-803	162	MN-73-066	141
MN-63-482	184	MN-65-413	188	MN-68-546/5	69	MN-68-942	73	MN-71-804	162	MN-73-067	141
MN-63-484	184	MN-65-511	187	MN-68-547/5	69	MN-68-945	73	MN-71-804-A	162	MN-73-102	148
MN-63-487	184	MN-65-522	188	MN-68-548/5	69	MN-68-961	72	MN-72-076	141	MN-73-106	149
MN-64-027	104	MN-65-523	188	MN-68-549/5	69	MN-68-962	72	MN-72-078	141	MN-73-107	149
MN-64-029	104	MN-65-524	188	MN-68-550/5	69	MN-68-965	72	MN-72-080	141	MN-73-115	149
MN-64-090	104	MN-65-525	188	MN-68-551/5	69	MN-68-966	72	MN-72-100	141	MN-73-130	149
MN-64-092	104	MN-65-526	188	MN-68-552/5	69	MN-68-967	72	MN-72-130	141	MN-73-160	149
MN-64-094	104	MN-65-528	188	MN-68-553/5	69	MN-69-013	189	MN-72-131	141	MN-73-162	150
MN-64-096	104	MN-65-530	188	MN-68-554/5	69	MN-69-014	189	MN-72-132	141	MN-73-165	150
MN-64-206	105	MN-65-542	188	MN-68-555/5	69	MN-69-015	189	MN-72-133	141	MN-73-176	150
MN-64-208	105	MN-65-543	188	MN-68-605	71	MN-69-016	189	MN-72-134	141	MN-73-178	150
MN-64-210	105	MN-65-544	188	MN-68-606	71	MN-69-112	77	MN-72-135	141	MN-73-180	150
MN-64-212	105	MN-65-550	189	MN-68-608	72	MN-69-114	77	MN-72-136	142	MN-73-182	151
MN-64-215	105	MN-65-621	66	MN-68-609	71	MN-69-121	77	MN-72-370	142	MN-73-185	151
MN-64-218	105	MN-65-622	66	MN-68-611	71	MN-69-122	77	MN-72-371	142	MN-73-193	151
MN-65-006	186	MN-65-640	188	MN-68-620	70	MN-69-134	78	MN-72-372	142	MN-73-194	151
MN-65-010	186	MN-66-722	184	MN-68-622	70	MN-69-135	78	MN-72-373	142	MN-73-260	147
MN-65-013	186	MN-67-060	184	MN-68-624	71	MN-69-142	76	MN-72-374	142	MN-73-330	148
MN-65-131	187	MN-67-062	184	MN-68-801	69	MN-69-144	76	MN-72-375	142	MN-73-336	148
MN-65-135	187	MN-67-064	184	MN-68-803	69	MN-69-164	77	MN-72-502	142	MN-73-338	148
MN-65-143	186	MN-67-066	184	MN-68-804	69	MN-69-165	77	MN-72-504	142	MN-73-339	148
MN-65-148	153	MN-67-068	184	MN-68-806	69	MN-69-172	77	MN-72-506	142	MN-73-340	148
MN-65-164	67	MN-67-070	184	MN-68-811	73	MN-69-173	77	MN-72-508	142	MN-73-341	148
MN-65-165	67	MN-67-072	184	MN-68-812	73	MN-69-175	77	MN-72-510	142	MN-73-370	147
MN-65-166	67	MN-67-075	184	MN-68-813	73	MN-69-191	77	MN-72-522	142	MN-73-371	148
MN-65-167	67	MN-67-080	184	MN-68-814	73	MN-69-193	77	MN-72-524	142	MN-73-380	147
MN-65-168	67	MN-67-082	184	MN-68-815	73	MN-70-502	139	MN-72-526	142	MN-73-386	147
MN-65-169	67	MN-68-460/5	70	MN-68-821	73	MN-70-504	139	MN-72-528	142	MN-73-388	147
MN-65-170	67	MN-68-461/5	70	MN-68-822	73	MN-70-506	139	MN-72-530	142	MN-73-390	147

LIST OF INDEXES

Index	Page	Index	Page	Index	Page	Index	Page	Index	Page	Index	Page
MN-73-395	147	MN-76-017/C	153	MN-79-078	76	MN-81-186	132	MN-90-104	14	MN-94-153	32
MN-73-400	147	MN-76-104	65	MN-79-079	76	MN-81-188	132	MN-90-105	15	MN-94-153	43
MN-73-406	147	MN-76-120	65	MN-79-080	75	MN-81-203	133	MN-90-107	15	MN-94-190	79
MN-73-408	147	MN-76-122	65	MN-79-081	75	MN-81-205	133	MN-90-211	17	MN-94-192	79
MN-73-410	147	MN-76-123	65	MN-79-082	75	MN-81-208	133	MN-90-221	17	MN-94-193	79
MN-73-420	147	MN-76-124	65	MN-79-083	75	MN-81-211	133	MN-90-222	17	MN-94-194	79
MN-73-421	148	MN-76-125	65	MN-79-089	76	MN-81-221	133	MN-90-223	18	MN-94-196	79
MN-74-160	144	MN-76-126	65	MN-79-093	76	MN-81-231	133	MN-90-252	18	MN-94-197	79
MN-74-163	144	MN-76-127	65	MN-79-095	76	MN-81-232	133	MN-91-130	20	MN-94-198	79
MN-74-164	144	MN-76-128	65	MN-79-096	76	MN-81-252	133	MN-91-131	20	MN-94-199	79
MN-74-197	144	MN-76-130	153	MN-79-100	159	MN-83-020	133	MN-91-132	21	MN-94-200	79
MN-74-198	144	MN-76-206	64	MN-79-161	159	MN-83-022	133	MN-91-133	21	MN-94-201	79
MN-74-199	144	MN-76-208	64	MN-79-162	159	MN-83-024	133	MN-91-134	21	MN-94-202	79
MN-74-208	145	MN-76-210	64	MN-79-163	159	MN-83-026	133	MN-91-135	21	MN-94-203	79
MN-74-209	145	MN-76-212	64	MN-79-164	159	MN-83-030	133	MN-91-136	22	MN-95-004	46
MN-74-210	143	MN-76-225	64	MN-79-165	159	MN-83-040	134	MN-91-137	22	MN-95-005	46
MN-74-211	143	MN-76-235	64	MN-79-221	151	MN-83-042	134	MN-91-138	22	MN-95-006	46
MN-74-212	143	MN-76-245	64	MN-79-355	159	MN-83-050	134	MN-91-139	23	MN-97-043	67
MN-74-218	144	MN-76-255	64	MN-79-356	159	MN-83-055	134	MN-91-140	23	MN-97-904	78
MN-74-219	144	MN-76-268	64	MN-79-357	160	MN-83-057	134	MN-91-141	24	MN-97-906	78
MN-74-220	144	MN-76-290	64	MN-79-358	160	MN-83-060	140	MN-91-142	24	MN-97-909	78
MN-74-221	144	MN-76-294	64	MN-79-360	160	MN-83-062	140	MN-91-143	24	MN-97-960	78
MN-74-303	145	MN-76-298	64	MN-79-365	161	MN-83-068	140	MN-91-144	25	MN-97-980-1	78
MN-74-304	145	MN-76-306	64	MN-79-370	161	MN-83-100	134	MN-91-146	25	MN-97-980-5	78
MN-74-305	145	MN-76-308	64	MN-79-375	161	MN-83-102	134	MN-91-147	25	MN-97-980-B	78
MN-74-318	143	MN-76-310	64	MN-79-400	161	MN-85-100	135	MN-91-148	23	MN-97-993-1	78
MN-74-320	143	MN-76-312	64	MN-79-401	161	MN-85-101	135	MN-91-501	20	MN-97-993-5	78
MN-74-328	144	MN-76-320	153	MN-79-402	162	MN-88-015	155	MN-92-014	39	MN-97-993-B	78
MN-75-071	151	MN-76-322	153	MN-79-403	162	MN-88-018	155	MN-92-015	39	MN-97-994-1	79
MN-75-242	152	MN-76-324	153	MN-79-405	160	MN-88-022	155	MN-92-091	41	MN-97-994-5	79
MN-75-243	152	MN-76-326	153	MN-79-406	160	MN-88-026	155	MN-92-101	39	MN-97-994-B	79
MN-75-246	152	MN-78-132	74	MN-80-151	131	MN-88-032	155	MN-92-102	40	MN-97-995-1	79
MN-75-247	152	MN-78-133	74	MN-80-152	131	MN-88-033	155	MN-92-103	40	MN-97-995-5	79
MN-75-286	152	MN-78-135	74	MN-80-162	131	MN-88-034	155	MN-92-207	42	MN-97-995-B	79
MN-75-288	152	MN-78-212	74	MN-80-171	131	MN-88-035	155	MN-92-304	33	MN-97-996-1	79
MN-75-290	152	MN-78-213	74	MN-80-172	131	MN-88-036	155	MN-92-405	45	MN-97-996-5	79
MN-75-502	152	MN-78-215	74	MN-80-212	131	MN-88-080	156	MN-92-501	40	MN-97-996-B	79
MN-75-503	152	MN-78-220	74	MN-81-023	131	MN-88-080/T	156	MN-93-011	30	MN-97-997-1	79
MN-75-504	152	MN-78-312	74	MN-81-025	131	MN-88-081	156	MN-93-015	45	MN-97-997-5	79
MN-75-511	152	MN-78-313	74	MN-81-028	131	MN-88-081/T	156	MN-93-016	45	MN-97-997-B	79
MN-76-000	153	MN-78-315	74	MN-81-030	131	MN-88-082	156	MN-93-022	29	MN-99-003	36
MN-76-000/C	153	MN-78-411	74	MN-81-113	132	MN-88-082/T	156	MN-93-034	29	MN-99-005	36
MN-76-001	153	MN-78-412	75	MN-81-115	132	MN-88-083	156	MN-93-035	28	MN-99-006	36
MN-76-001/C	153	MN-78-413	75	MN-81-132	132	MN-88-083/T	156	MN-93-036	28	MN-99-206	37
MN-76-002	153	MN-79-011	154	MN-81-133	132	MN-88-090	156	MN-93-037	28	MN-99-207	37
MN-76-002/C	153	MN-79-012	154	MN-81-135	132	MN-88-090/T	156	MN-93-038	29	MN-99-921	47
MN-76-003	153	MN-79-013	154	MN-81-137	132	MN-88-091	156	MN-93-039	30	MN-99-922	47
MN-76-003/C	153	MN-79-018	155	MN-81-143	132	MN-88-091/T	156	MN-93-210	41		
MN-76-004	153	MN-79-061	75	MN-81-145	132	MN-88-100	156	MN-93-215	41		
MN-76-005	153	MN-79-063	75	MN-81-148	132	MN-88-100/T	156	MN-93-220	32		
MN-76-010	154	MN-79-069	75	MN-81-152	132	MN-88-101	156	MN-93-225	32		
MN-76-011	154	MN-79-071	75	MN-81-153	132	MN-88-101/T	156	MN-93-307	42		
MN-76-011/C	153	MN-79-073	75	MN-81-155	132	MN-90-031	13	MN-94-008	35		
MN-76-013	154	MN-79-074	75	MN-81-156	132	MN-90-032	13	MN-94-009	35		
MN-76-014	154	MN-79-075	76	MN-81-158	132	MN-90-033	13	MN-94-010	35		
MN-76-016	153	MN-79-076	76	MN-81-183	132	MN-90-034	14	MN-94-151	42		
MN-76-016/C	153	MN-79-077	76	MN-81-185	132	MN-90-035	14	MN-94-152	43		

MODECO EXPERT

AUSTRALIA

Rawlplug Australia
255 Whitehorse Road
Suite 7, Level 1
Balwyn, Vic 3103
Tel: + 61 428 647 745
Email: craig.salmon@rawlplug.com
Web: www.rawlplug.com

GERMANY

Koelner Deutschland GmbH
Gmünder Str. 65
73614 Schorndorf
Tel: +49 (0) 7181 977 72-0
Email: info@koelner-befestigung.de
Web: www.rawlplug.com

ITALY

Rawlplug Italy S.r.l.
Via Privata Euro Industrie n. 4/6
20052 - Vignate (MI)
Tel: +39 02 50309590
Email: informazioni@rawlplug.com
Web: www.rawlplug.it

RUSSIA

Koelner Trading KLD LLC
ul. Dzerzhinskogo 219
236034 Kaliningrad
Tel: + 7 (4012) 65 85 75
Email: info@koelner-trading.ru
Web: www.koelner-trading.ru

SWEDEN

Rawl Scandinavia AB
Baumansgatan 4
593 32 Västervik
Tel: +46(0)490 30660
Email: info@rawlplug.se
Web: www.rawlplug.se

UNITED ARAB EMIRATES

Rawlplug Middle East FZE
P.O. Box 261024 Dubai, UAE
Warehouse No. RA08BC01
Tel: + 971 (4) 8839 501
Email: dubai@rawlplug.co.uk
Web: www.rawl.ae

CHINA

Rawlplug Shanghai Trading Co., Ltd.
Room B209, No. 139 Fanghua Road,
Pudong, Shanghai
P.R. China Post code 201204
Tel: +86 189 1882 8527
Email: Jennifer.Song@rawlplug.com
Web: www.rawlplug.com

HUNGARY

Koelner Hungária Kft
Jedlik Ányos út. 34
2330 Dunaharaszti
Tel: + 36 (24) 520 400
Email: info@koelner.hu
Web: www.koelner.hu

LITHUANIA

UAB Koelner Vilnius
Žarijų g. 2
LT-02300, Vilnius
Tel: + 370 (5) 2324 862
Email: koelner@koelner.lt
Web: www.koelner.lt

SINGAPORE

Rawlplug Singapore Pte. Ltd.
Blk 302, #04-11, 25B Loyang Crescent
Loyang Offshore Supply Base
Singapore 506817
Tel: + 65 9078 5220
Email: jacek.nowicki@rawlplug.com.sg
Web: www.rawlplug.com

THAILAND

Rawlplug Manufacturing (Thailand) Limited
Address: 888/43 Moo 9
T.Bangpla, A. Bangplee
Samutprakarn 10540
Thailand
Tel.: +662 731 4788
Web: www.rawlplug.com

UNITED KINGDOM

Rawlplug Ltd
Skibo Drive
Thornliebank Industrial Estate
Glasgow G46 8JR
Tel: + 44 (0) 141 638 7961
Fax: + 44 (0) 141 638 7397
Email: rawlinfo@rawlplug.co.uk
Web: www.rawlplug.co.uk

CZECH REPUBLIC

Koelner CZ s.r.o
Palackého 1154/76A
702 00 Ostrava-Privoz
Tel: + 420 596 636 A 397
Email: objednavky@rawlplug.cz
Web: www.koelner.cz
Web: www.rawlplug.cz

INDIA

Rawlplug Products and Services India Private Limited
Head Office: +91 08 4302 2234
#29, Prestige Meridian - I 503, M.G.Road,
Bangalore – 560001, Karnataka, India
Tel: 91 – 7356209642
Email: india@rawlplug.com
Web: rawlplug.com

POLAND

Rawlplug S.A.
ul. Kwidzińska 6
51-416 Wrocław
Tel: +48 (71) 32 60 100
Fax: +48 (71) 37 26 111
Email: info@rawlplug.com
Web: www.rawlplug.com

SLOVAKIA

Koelner Slovakia, s.r.o.
Jánošíkova 1
010 01 Žilina
Tel: + 421 415 003 900
Email: objednavky@rawlplug.sk
Web: www.koelner.sk
Web: www.rawlplug.sk

TURKEY

Rawlplug Turkey Insaat Malzemeleri LTD. STI.
FSM mah. Poligon cad. Buyaka 2
sitesi 3 blok NO8C/1
Umraniye /I stanbul
Tel.: +905 449 300 261
Web: www.rawlplug.com

UNITED STATES OF AMERICA

Rawlplug Inc.
225 West Washington Ste 2600
Chicago IL 60605
Tel.: +1 312 940 5102
Web: www.rawlplug.us

FRANCE

RAWLPLUG France
Bâtiment DC6, ZAC de la Feuchère
16, rue Jean Mermoz
77290 Compans
Tel: + 33 (0) 1 6021 5020
Email: rawl@rawlplug.com
Web: www.rawlplug.fr

IRELAND

Rawlplug Ireland Ltd
Unit 10 Donore Business Park
Donore Road Drogheda
Co Louth A92 C522
Tel: + 353 (0) 41 9844 338
Email: sales@rawlplug.ie
Web: www.rawlplug.ie

PORTUGAL

Rawlplug Lda
Business Park Maia
Rua Eng Frederico Ulrich 3110, B1
4470-605 Maia, Portugal
Email: pt.clientes@rawlplug.com
Tel: +351 221 174 633
Web: www.rawlplug.pt

SPAIN

Rawlplug Lda
Business Park Maia
Rua Eng Frederico Ulrich 3110, B1
4470-605 Maia, Portugal
Email: es.clientes@rawlplug.com
Tel: +34 653 782 215
Web: www.rawlplug.es

UKRAINE

Koelner Ukraine LLC
Lvivska Bichna, 6
Sokilnyky
Pustomyty Dstr., Lviv Reg. 81130
Tel.: + 380 (32) 2440 744
Email: koelner@koelner.ua
Web: www.koelner.ua

VIETNAM

Factory A_18_4_B, C, D, E, Lot A_18_CN
Bau Bang Industrial Park, Lai Uyen Town
Bau Bang District,
Binh Duong Province
Vietnam, 75700
Email: info@rawlplug.com

CENTRAL TOOL SERVICE

phone: +48 (71) 320 92 18

serwis@rawlplug.com

CUSTOMER SERVICE

phone: +48 (71) 32 60 100

bok@rawlplug.com